A photograph of the Toronto skyline at dusk, featuring the CN Tower and several modern high-rise buildings. The sky is blue with scattered white clouds, and the water in the foreground reflects the buildings and the sky. A semi-transparent green box is overlaid on the right side of the image, containing the title text.

The City of Toronto

# ZERO EMISSIONS BUILDINGS FRAMEWORK

Prepared for the City Planning Division, City of Toronto by



### Client Representatives

**Lisa King**, *City Planning Division, City of Toronto*

**Bryan Purcell**, *The Atmospheric Fund*

**Nickolas Lysenko**, *Environment and Energy Division, City of Toronto*

**March 2017**

### Advisory Committee Members

**Geoff Gibson**, *The Daniels Corporation*

**Heather Black**, *Ministry of Municipal Affairs & Housing, Ontario Building Code*

**Mark Gorgolewski**, *Ryerson University*

**Steve Kemp**, *RDH Building Science*

**Wells Baker**, *The Minto Group*

**Eva Muso**, *Ministry of the Environment and Climate Change*

**Anna Palamarchuk**, *Waterfront Toronto*

**Subhi Alsayed**, *Tridel/Tower Labs*

**Bob Bach**, *Sustainable Buildings Canada*

**Shawn Good**, *Building & Land Development Association*

**Michael Leckman**, *Diamond & Schmitt Architects*

**Jenny McMinn**, *BuildGreen Solutions*

**Bryan Purcell**, *The Atmospheric Fund*

**Julia St. Michael**, *REALPAC*

**Douglas Webber**, *WSP Canada Inc.*

**Corey McBurney**, *enerQuality Corporation*

# TABLE OF CONTENTS

<b>EXECUTIVE SUMMARY</b>	<b>5</b>
<b>1. INTRODUCTION</b>	<b>11</b>
1.1. TORONTO'S CLIMATE & ENERGY TARGETS	12
1.2. REDUCING BUILDING EMISSIONS IN TORONTO	13
1.3. THE TORONTO GREEN STANDARD	15
1.4. ADAPTING TO CLIMATE CHANGE	16
1.5. CREATING A NEW FRAMEWORK	17
1.6. HOW TO READ THIS REPORT	19
<b>2. GLOBAL BEST PRACTICES IN ENERGY EFFICIENCY POLICY</b>	<b>20</b>
2.1. APPROACHES TO BUILDING ENERGY PERFORMANCE	22
2.2. MOVING TO A TARGETS-BASED APPROACH	24
2.3. SELECTING METRICS	25
2.4. PRESCRIPTIVE REQUIREMENTS	27
2.5. ESTABLISHING A PERFORMANCE PATHWAY	28
2.6. SUMMARY OF RECOMMENDATIONS	29
<b>3. TORONTO'S ZERO EMISSIONS BUILDINGS FRAMEWORK</b>	<b>30</b>
3.1. METRICS AND TORONTO BUILDING ARCHETYPES	31
3.2. SETTING TARGETS	33
3.3. ASSESSING COSTS OF CONSTRUCTION	34
3.4. MODELLING BUILDING RESILIENCE	35
3.5. A PATHWAY TO ZERO	36
3.6. HIGH-RISE MULTI-UNIT RESIDENTIAL BUILDINGS	37
3.7. LOW-RISE MULTI-UNIT RESIDENTIAL BUILDINGS	40
3.8. COMMERCIAL OFFICE BUILDINGS	42
3.9. RETAIL BUILDINGS	44
3.10. MIXED USE BUILDINGS	46
3.11. MAJOR RETROFITS & OTHER BUILDING TYPES	47
<b>4. PRESCRIPTIVE &amp; ADMINISTRATIVE REQUIREMENTS</b>	<b>48</b>
4.1. RENEWABLE ENERGY GENERATION	50
4.2. LOW-CARBON THERMAL ENERGY NETWORKS (DISTRICT ENERGY SYSTEMS)	52
4.3. AIR TIGHTNESS TESTING	55

4.4. BUILDING COMMISSIONING . . . . .	57
4.5. SUBMETERING . . . . .	59
4.6. ENERGY BENCHMARKING AND DISCLOSURE . . . . .	60
4.7. ENERGY MODELLING GUIDELINES . . . . .	61
4.8. CLIMATE CHANGE RESILIENCE CHECKLIST . . . . .	62
<b>5. IMPLICATIONS FOR BUILDING CONSTRUCTION</b>	<b>64</b>
5.1. PASSIVE DESIGN STRATEGIES . . . . .	66
5.1. HIGH EFFICIENCY MECHANICAL & ELECTRICAL SYSTEMS . . . . .	71
5.2. LOW-CARBON ENERGY SOURCES . . . . .	72
<b>6. IMPLICATIONS FOR BUILDING COSTS</b>	<b>73</b>
<b>7. SUMMARY &amp; NEXT STEPS</b>	<b>77</b>
7.1. IMPLEMENTATION & CAPACITY BUILDING . . . . .	79
7.2. INCENTIVIZING PERFORMANCE . . . . .	81
GLOSSARY . . . . .	83
Appendix A – Performance Targets – All Buildings . . . . .	84
Appendix B – Archetype Descriptions & Modelling Input Summaries . . . . .	85
Appendix C – Parametric Modelling Results . . . . .	96
Appendix D – Costing Analysis Results . . . . .	100
Appendix E – Summary of Prescriptive Requirements & Checklist . . . . .	108
Appendix F – Resilience Checklist . . . . .	109
RESOURCES & REFERENCES CITED . . . . .	117



# EXECUTIVE SUMMARY



***“...how can Toronto address its growing carbon emissions while continuing to prosper and ensure the construction of safe and durable buildings for its residents?”***

## INTRODUCTION

As the City of Toronto adds an estimated 24,400 more people per year, the demand for both residential and non-residential developments is growing. In fact, between 2011 and 2015, the City added an additional 85,166 residential units and 2.69 million m<sup>2</sup> of non-residential floor area, making Toronto one of the fastest growing cities in North America.

But with rapid growth comes increased challenges. How can Toronto address its growing carbon emissions while continuing to prosper and ensure the construction of safe and durable buildings for its residents? How can it ensure that buildings built today will be ready for the changes in climate that we are expected to experience into the future?

The City of Toronto has committed to an ambitious set of City-wide energy and greenhouse gas (GHG) reduction targets, including a goal of reducing GHG emissions by 80% of 1990 levels by 2050. To reduce the demands placed on provincial power generation infrastructure and reduce emissions, the City has also pledged to increase renewable and district energy generation across the city.

Together, these goals and challenges indicate the need for an integrated building framework that can both reduce the impact of buildings on our environment while improving their resilience to climate change. The framework also needs to ensure a high level of both quality and enduring performance to protect Toronto's citizens and consumers from escalating energy costs. The foundation of such a framework already exists in the form of the Toronto Green Standard (TGS), a two-tier set of performance measures for new developments adopted by Toronto City Council in 2010. While the TGS has already established Toronto as a leader in energy efficiency standards, updating its requirements will ensure that Toronto remains at the fore of energy and climate change action while improving the quality of its built form.

## BEST PRACTICES IN ENERGY EFFICIENCY

This report presents the results of a two-part study designed to identify an effective means of updating the TGS greenhouse gas and energy efficiency measures that is both feasible for the construction industry and that addresses the city's climate, energy and resilience goals. Initial research on global best practices in energy efficiency requirements conducted in 2015 indicated that a shift from Toronto's current 'percent above' the Ontario Building Code approach to measuring energy performance to an absolute performance targets approach would help to close the gap between design and construction building performance. That shift would also help to ensure consistency between buildings, facilitate compliance, and improve energy performance overall. The results of the research also demonstrated the value of an interrelated set of performance targets that work together to encourage improvements in energy efficiency, reduce heating and cooling demand, and incentivize a shift towards low-emission sources of energy. Requiring such targets would yield additional benefits, such as reductions in peak energy demand, improved thermal comfort, and construction quality.

In a second phase of work, these findings were expanded upon to identify and develop performance targets appropriate for Toronto's building context. To ensure

the Framework's requirements are technically feasible and cost-effective, the modelling scenarios were tested and vetted with an Advisory Committee and technical experts throughout the study process. A series of energy and costing models were developed for Toronto's top five building types: High-Rise and Low-Rise Residential, Commercial Office, Retail, and Mixed Use buildings. Incremental energy use, thermal demand and greenhouse gas intensity (GHGI) targets were developed through parametric modelling and analysis for each of the five building types out to a zero emissions date of 2030. The 2030 date was established as critical to meeting Toronto's city-wide GHG reduction target of 80% by 2050.

Building resilience to extreme weather was assessed as a co-benefit in the modelling and analysis leading to a fuller understanding of the impact of thermal envelope performance on indoor livable temperatures and back-up power reserves. As a result of this process, the energy efficiency, GHG reduction, and resilience results contained within the Framework reflect careful assessment that ensures they are both ambitious and feasible given existing trends, conditions, and capacities of Toronto's building community.

## TORONTO'S ZERO EMISSIONS BUILDINGS FRAMEWORK

The Framework comprises a full set of targets for the five most common building archetypes that require increasing levels of performance over time. Four tiers of performance were developed to take the building industry from today's building practices to a near-zero emissions level of performance by the year 2030. The establishment of this pathway to near-zero emissions building construction not only helps the City to meet its 2050 GHG reduction goals, but provides the building industry with a clear and transparent picture of future requirements. The emphasis on total energy use, thermal demand reduction and GHGI encourages a passive design-first approach coupled with high efficiency active systems, such as heat recovery, and improved air tightness. Tier 4 targets represent a near-zero level of emissions performance, at which point fuel switching is promoted to foster a shift away from natural gas towards electricity and renewable energy sources.

In summary, under the Framework, new developments in Toronto will be required to reach select levels of performance in three primary metrics:

- **TOTAL ENERGY USE INTENSITY**, to encourage higher efficiency buildings and lower utility costs;
- **THERMAL ENERGY DEMAND INTENSITY**, to encourage better building envelopes, improve occupant comfort and enhance resilience; and
- **GHG INTENSITY**, to encourage low-carbon fuel choices and reduce building emissions.

To supplement the performance targets, a set of new or updated prescriptive requirements have also been recommended to help ensure modelled performance targets are realized in practice. These requirements extend to the following areas:

- **RENEWABLE ENERGY GENERATION**: Buildings designed to either accommodate connection to solar technologies, or to supply their

total energy load with 5% from renewable energy sources or 20% with geexchange, will help Toronto to meet its renewable energy generation targets.

- **DISTRICT ENERGY CONNECTION:** Buildings designed to enable connection or actually connect to a district energy system (where one exists or is slated for development) will help the City of Toronto to reduce emissions from the buildings sector.
- **AIR TIGHTNESS TESTING REQUIREMENTS:** Requiring buildings to conduct whole building air tightness testing helps to improve the quality and airtightness of the building envelope, as well as the performance gap between building design and performance.
- **BUILDING COMMISSIONING REQUIREMENTS:** Fundamental commissioning and enhanced commissioning requirements help to ensure that buildings are constructed and operated properly, improving overall building energy performance.
- **SUBMETERING:** Submeters installed by floor/defined use or by appliance/tenant will help to give a clear picture of building energy use.
- **BUILDING LABELING AND DISCLOSURE:** Requirements for buildings to annually report their energy consumption aligns with Provincial requirements, while naming the City of Toronto ensures the City can track and help to improve buildings' energy performance over time.

The Framework also includes an updated set of **Energy Modelling Guidelines** to clarify key inputs and methods of calculating energy performance, help support applicants achieve compliance, and improve consistency between buildings. A **Climate Change Resilience Checklist for New Development** has also been included to encourage the construction of safe and resilient buildings that are able to withstand expected changes in climate.





## SUPPORTING THE INDUSTRY

The GHG emissions reductions that can be achieved using the proposed Framework have been estimated at **30.6 megatonnes by the year 2050**, making it a powerful tool in the City's progress towards its climate change targets. However, support for Toronto's building industry will be necessary to see it reach its full potential. The Framework has been designed to elicit changes to building design that will favour the use of passive design strategies that minimize building energy demand and improve occupant comfort. To help Toronto's building industry make this shift, this report provides an overview of key design strategies that, if used, will help to ensure targets are met. As the Framework unfolds, the City of Toronto will explore options to help support the building design and construction industry, and build its capacity to take on future requirements. However, the City's innovative development community is already well-positioned to meet its targets and make Toronto's buildings among the best in the world.

## A NATIONAL MOVEMENT

The City of Toronto is not alone in its efforts to reduce building emissions – several other cities and municipalities have also committed to reducing their emissions by 80% below 1990 levels by 2050, and have begun to explore similar ways of reducing greenhouse gases from their building stock. Among these, the City of Vancouver is a notable leader in the recent implementation of their *Zero Emissions Buildings Plan*. Leading building industry organizations are also beginning to develop voluntary standards to encourage the construction of high performance, low-carbon buildings. The Canada Green Building Council released its *Zero Carbon Building Framework* in 2016, and is in the process of creating an associated Zero Carbon certification program. These and other actions being taken across the country contribute to a cross-Canadian movement to improve building codes and performance standards. This Framework will help to support the City of Toronto in raising the awareness and capacity of the industry to realize new levels of building performance.

---

***“The proposed Framework would ensure the construction of high quality buildings that simultaneously reduce their impact on the environment.”***

---

# ZERO EMISSIONS BUILDING FRAMEWORK

The City of Toronto is one of the fastest growing cities in North America, and faces the challenge of providing for a growing population while reducing its carbon emissions. The **Zero Emissions Building Framework** provides an integrated approach to addressing some of the City of Toronto's key priorities.

## CITY PRIORITIES

01 Improve building energy efficiency to reduce energy costs and stresses on the electrical grid



02 Enhance resilience to the impacts of climate change, including heat waves, power outages, and flooding



03 Decrease GHG emissions by 80% below 1990 levels, increasing local renewable and district energy generation



## NEW TARGETS

TEUI

Total Energy Use Intensity targets lower overall energy use and utility costs

TEDI

Thermal Energy Demand Intensity targets ensure buildings have better envelopes that save energy and improve resilience

GHGI

GHG Intensity targets encourage low-carbon fuel choices and reduce building emissions

## BUILDING BETTER BUILDINGS



Benchmarking and submetering requirements ensure energy performance can be tracked and improved over time



Renewable energy targets increase low-carbon energy generation and safeguard against power outages



A resilience checklist improves the safety and security of buildings during extreme events



Air tightness testing ensures building envelopes keep indoor temperatures comfortable



Building commissioning ensures that buildings are constructed and operated properly

## PATHWAY TO ZERO EMISSIONS

2018  
2022  
2026  
2030

TEUI



TEDI



GHGI

ZERO EMISSIONS

- ✓ Lower GHG emissions and lower energy costs
- ✓ Guidance for energy modellers, designers and owners
- ✓ Better, safer buildings for occupants
- ✓ Stringent but achievable targets

30.6

The new framework will help Toronto reduce its emissions by **30.6 megatonnes by 2050!**

# 1. INTRODUCTION



# 1.1. TORONTO'S CLIMATE & ENERGY TARGETS

The City of Toronto has joined an international community of leading cities who have committed to combating climate change through the implementation of several plans and strategies over the last ten years. In 2007, Toronto adopted the Climate Change and Clean Air Action Plan, which outlined a number of actions to reduce the release of greenhouse gas (GHG) emissions and improve the City's air quality. Alongside the Plan, the City of Toronto also adopted a set of specific community-wide GHG reduction targets, including:

- 6% below 1990 levels by 2012;
- 30% below 1990 levels by 2020; and
- 80% below 1990 levels by 2050.<sup>i</sup>

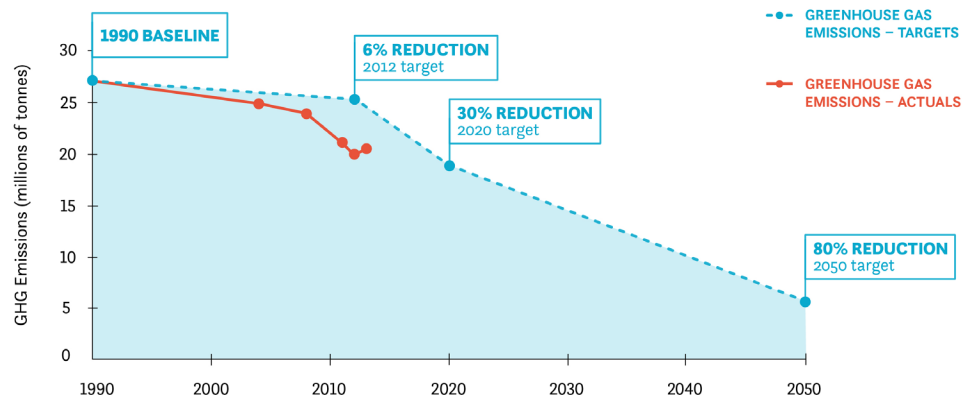

Figure 1: Toronto's Greenhouse Gas Emissions and Targets (Source: TransformTO)

These goals were further articulated in 2009 in the City's Sustainable Energy Strategy, which outlined specific targets for reducing electricity, conserving natural gas, and increasing renewable energy generation (see Table 1). The City has since prioritized the use of conservation and demand management measures, while increasing small scale renewable energy generation and smart energy distribution.<sup>ii</sup> The City has also begun to explore and prepare measures to accelerate the implementation of low-carbon district energy systems in Toronto as a potential means of reducing building emissions.

**“The City has since prioritized the use of conservation and demand management measures, while increasing small scale renewable energy generation and smart energy distribution.”**

Table 1: Conservation Targets (2009 Sustainable Energy Strategy)

SOURCE	2020 TARGET	2050 TARGET
Electricity conservation	550 MW reduction	1050 MW reduction
Natural gas conservation	730 Mm <sup>3</sup> reduction	1650 Mm <sup>3</sup> reduction
Renewable energy generation	550 MW increase	1000 MW increase
Renewable thermal energy	90 Mm <sup>3</sup> of natural gas displaced	200 Mm <sup>3</sup> of natural gas displaced

A number of policies and measures have already been implemented to help move the City towards the achievement of these ambitious energy and emissions goals. However, there is still a considerable gap between the impact that these policies and measures will have, and the 80% reduction of emissions targeted by the City.<sup>1</sup>

To help close this gap and reduce Toronto's emissions down below 80% from 1990 levels, a multi-stakeholder collaboration was created in 2015 in the form of TransformTO.<sup>iii</sup> TransformTO's primary function is to supplement the City's Climate Change Action Plan and Sustainable Energy Strategy and accelerate Toronto's transformation towards a sustainable city. To date, TransformTO has conducted extensive processes of stakeholder consultation and technical analysis to determine the actions and investments required to meet the City's 2050 target. Many of these strategies are supported by the Province of Ontario's recent *Five Year Climate Change Action Plan (2016-2020)*, which outlines a number of steps to reduce emissions from fossil fuels across a number of sectors.<sup>iv</sup>

## 1.2. REDUCING BUILDING EMISSIONS IN TORONTO

TransformTO's first *Staff Progress Report (2016)* outlines several key short-term strategies to immediately begin to fund and implement emissions reductions. Many of these strategies address emissions from buildings, which account for approximately 48% of Toronto's total emissions (see Figure 2).<sup>v</sup> These will be particularly important given Toronto's current building market: today's construction trends include significant intensification in both residential and commercial construction in the city's core and near key transit nodes. Building developers in select sectors are also responding to high costs of land and labour by minimizing floor-to-floor heights and residential suite sizes, and using lower cost building materials. While mid-rise construction is being encouraged along key boulevards and in infill sites across the city, high-rise construction is trending towards an overall increase in building heights.

Such practices can create challenges for efforts to reduce energy use and GHG emissions. High-rise residential and office buildings tend to use cladding materials and envelope systems that allow high rates of heat transfer between the inside and outside of the building, reducing their overall thermal energy efficiency. Instances

1. The TransformTO 2016 staff report found an 8.7 million tonne gap between a Business-As-Usual scenario and the 80% reduction by 2050 target.

of heat transfer via envelope components (a process known as ‘thermal bridging’) are not only common, but tend to be ignored when modelling building energy performance, leading to overestimations of actual building performance. High window-to-wall ratios (upwards of 80% in office buildings) further contribute to lower energy efficiency and higher demand for energy in both winter and summer months.

“...the energy performance of Toronto’s building stock remains relatively low, with considerable room for improvement.”

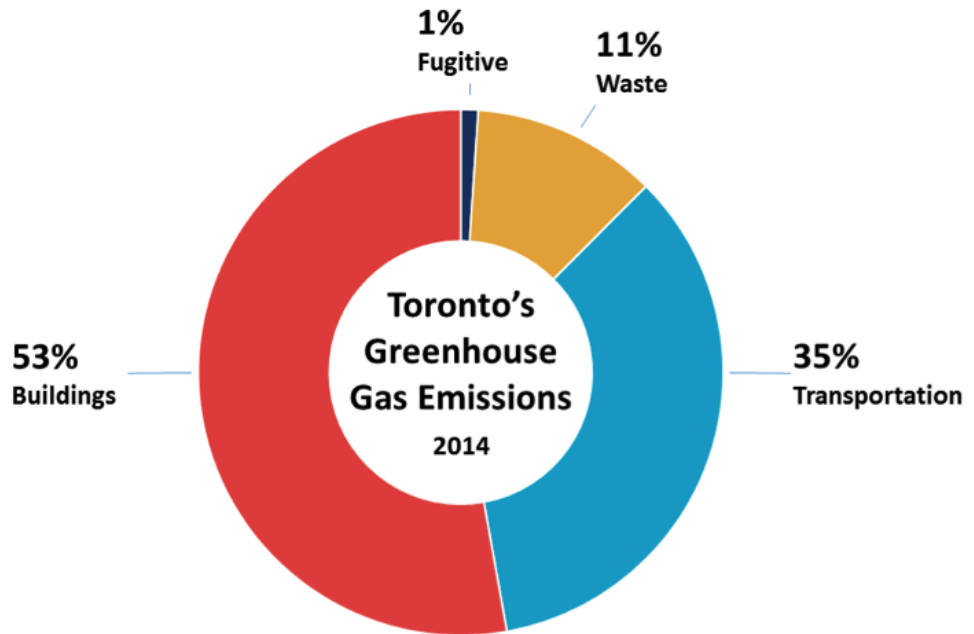

Figure 2: Toronto's emissions by sector, 2014 (Source: TransformTO)

Of course, some of Toronto’s leading developers are targeting better energy and emissions performance using standards such as the Toronto Green Standard’s voluntary second tier of performance (see below), and LEED for New Construction. In the high-rise office market, for example, LEED certification has become a prevalent phenomenon, especially among Class A buildings. In the residential sector, LEED certification is less common as a result of limited market traction. While energy efficiency features are sometimes offered as a marketing tool for residential end users, they remain fairly limited when compared to other marketable features such as higher quality finishes, building amenities, and large suites. As such, the energy performance of Toronto’s building stock remains relatively low, with considerable room for improvement.



## 1.3. THE TORONTO GREEN STANDARD

The City of Toronto began to address these challenges in 2010 with the release of the Toronto Green Standard (TGS). The TGS has already positioned Toronto as one of the country's leaders in energy efficiency standards for new development by creating a two-tier set of performance measures for new developments in Toronto, and includes a number of targets for GHG emissions and energy efficiency. All new planning applications, including zoning bylaw amendments, site plan approvals, and draft plans of subdivisions are required to meet Tier 1 of the Toronto Green Standard, while the achievement of the more stringent Tier 2 is voluntary. Projects that aim for Tier 2 are offered an incentive in the form of a partial refund of Development Charges (DC) to support early adoption and innovation. Tier 2 performance levels also form the basis for the next performance baseline (Tier 1) in updated versions of the TGS.

A more stringent version of the TGS (Version 2.0) came into effect in 2014, which raised energy efficiency requirements to 15% over the Ontario Building Code (OBC, 2012) for Tier 1 and 25% above the OBC for Tier 2. The DC refund incentive program has proven to be an effective tool to pull the market forward and build examples of high quality green buildings. The program has also shown continuous growth since its inception in 2010 with an average of 15% of eligible development projects enrolled in the program, and 15 certified Tier 2 buildings as of 2017.

**Passive survivability** refers to a building's ability to maintain critical life-support functions and conditions for its occupants during extended periods of absence of power, heating fuel, and/or water.

**Thermal resilience** is one dimension of passive survivability, and refers to a building's ability to maintain liveable indoor temperatures in the event of a power outage or disruption in fuel supply for prolonged periods of time.

However, to maintain a position of leadership and continue to reap the benefits of high performance building construction, it is necessary to review and update the TGS at regular intervals. Among the strategies to accelerate emissions reductions proposed by TransformTO, the need to 'raise the bar' for new construction and low carbon community planning was highlighted as a key action. Implementing this recommendation through the TGS will ensure that it remains a rigorous standard that evolves alongside new information and new political, technological, and programmatic opportunities.

Requiring higher performance levels for new construction will reduce the GHG impact of population growth and densification, replace poorer-performing buildings with high-performance buildings that improve occupant comfort, and build industry capacity in high performance design and construction. These efforts won't be taken in isolation, but will be complemented by several actions outlined by the Province, including efforts to improve energy efficiency in existing buildings, and set lower carbon standards for new construction via updates to the Ontario Building Code (OBC). Indeed, the 2017 update of the OBC provides an additional impetus for an update to the TGS to ensure that it continues to align with and build upon Provincial requirements.

## 1.4. ADAPTING TO CLIMATE CHANGE

Alongside the need to reduce Toronto's emission and thus its contribution to climate change, the City of Toronto has also recognized the need to prepare its systems and citizens for the impacts of a warming world. In 2008, the City adopted the set of recommendations contained within its *Climate Change Adaptation Strategy*, which included actions designed to protect the health of Torontonians, improve the resilience of city infrastructure and services, reduce impacts on the natural environment, and maintain a thriving economy.<sup>vi</sup>

The City continued to work towards improving Toronto's resilience to climate change through the development of a Climate Change Risk Assessment Tool in 2010, and commissioned a report on future climate and weather conditions in 2011. Toronto's *Future Weather and Climate Driver Study* outlines the changes in temperature, precipitation, and wind patterns that Toronto can expect over the next few decades to help the City to administer and fund upgrades to infrastructure and services.<sup>vii</sup>

Toronto has since adopted two reports on building a more resilient Toronto – Resilient City: Preparing for Extreme Weather Events (2013) and Resilient City: Preparing for a Changing Climate (2014). Among the actions that the City will need to take to ensure Toronto's resilience is designing and constructing buildings to withstand extreme weather disruptions and provide a refuge during periods of shocks or stresses. Broad changes anticipated for Toronto include increases in both summer and winter temperatures, extreme heat events (i.e. heat waves), and the severity and magnitude of precipitation events.





The overall impact of these changes in climate on the building sector will be primarily experienced in Toronto as a higher risk of flooding events, extreme heat events, and power outages. To reduce the impact of these expected changes in climate on Toronto's building sector, new buildings must be constructed in such a way as to mitigate flood events, improve thermal resilience, and extend the duration of back-up power generation. This study sought to identify the necessities required for people to stay in place during a disruption, and whether high performance buildings tended to support resilience objectives.

## 1.5. CREATING A NEW FRAMEWORK

The City's proposed Zero Emissions Building Framework has been crafted as the building sector's response to climate change. The Framework is intended to ensure Toronto's buildings reduce the built environment's contribution to climate change, while improving its resilience to projected climate change impacts. As a whole, the Framework addresses three intersecting goals:

- **Increase building energy efficiency** to reduce overall energy demand from the built environment, reducing energy costs for residents and businesses;
- **Decrease GHG emissions** by shifting towards the use of lower carbon energy sources, including district energy systems where suitable, and;
- **Increase the thermal resilience of the buildings sector** to changing conditions and extreme events (see Figure 3).

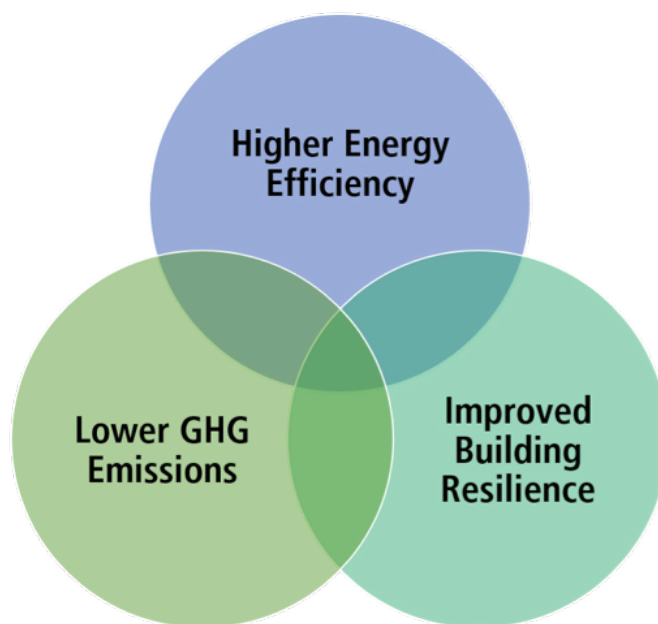

Figure 3: Intersections between Sustainability & Resilience

**“The end goal of the Framework is to ensure that all new buildings in Toronto will be constructed to a near zero emissions level of performance by the year 2030 or sooner.”**

The Framework is the product of a rigorous program of research and consultation to determine the highest caliber building standard possible for the City of Toronto. It represents the completion of a body of work for the City of Toronto, initiated in 2013, and a review of development projects constructed to existing TGS energy and emissions requirements conducted by the Energy Efficiency Office. Following a report of these findings to Toronto City Council, the Energy Efficiency Office was directed to explore a series of global standards for energy efficiency to inform an update to the performance requirements for the Toronto Green Standard (TGS). The *Global Best Practices in Energy Efficiency Policy* report, released in 2015<sup>viii</sup>, provided specific recommendations on how the TGS should evolve over time to ensure the City’s climate targets are met.

In the second phase of work, these recommendations have been explored in further depth to reflect the City of Toronto’s emerging priorities, including the need to ensure the city’s resilience in the face of a changing climate, and to support the use of decentralized, local, and integrated energy solutions. Toronto is experiencing significant population growth and rapid change in its built environment above and beyond changes in climate, including substantial development and redevelopment activity both in the central core and peripheral areas. Toronto is growing by an estimated 24,400 people per year, increasing demand for both residential and non-residential developments.

In 2015, 65% of the residential completions in the Greater Toronto Area (GTA) were built in the urban core. Between 2011 and 2015, Canada Mortgage and Housing recorded a total of 85,166 residential units completed in Toronto. 83% of these units were condominium apartments, an all-time high in Toronto’s development history.

The targets and requirements laid out in this Framework have been developed taking these and other economic, demographic, and aesthetic trends into consideration, and using input from a broad range of building industry stakeholders. The purpose of the Framework is not only to help the City meet its goals, but also to create a clearer long-term vision and simpler approach to building energy performance that both eases compliance for the building industry, and that provides better buildings and lower energy costs for the citizens of Toronto.

The targets and requirements proposed will be implemented in part using the existing TGS Version 3.0. The stepped performance pathway to zero emissions sets out a new approach to measuring and implementing energy performance and GHG improvements in the building sector. The pathway includes a four year update frequency that gradually increases energy and emissions performance requirements over time to ensure that Toronto remains a leader in building standards. The end goal of the Framework is to ensure that all new buildings in Toronto will be constructed to a near-zero emissions level of performance by the year 2030, or sooner. This is a critical step to meeting the City’s climate and energy targets, including the achievement of the City’s 80% reduction by 2050 goal. In fact, it has been estimated that the cumulative GHG emissions reductions that can be achieved through the implementation of the Framework is a noteworthy 30.6 megatonnes by the year 2050, making it an important emissions reduction tool.



## 1.6. HOW TO READ THIS REPORT

The goal of this report is to present an overview of the Zero Emissions Building Framework, but also to provide the building industry and the public with the context and information necessary to understand the rationale for the new approach, targets, timeline, and requirements that have been selected. Following this introduction, the report is organized into five additional sections, each of which can be read as its own stand-alone chapter.

- **SECTION 2** provides an overview of the background research that led to the rationale for a new approach to the TGS (Phase 1 Global Practices in Energy Policy Study), including the merits of a targets-based approach and the importance of establishing a framework and pathway for increasing targets over time;
- **SECTION 3** summarizes the full Zero Emissions Buildings Framework, including the methods used to determine specific targets, design packages of building strategies and building costs, and sets out a performance pathway to near-zero emissions;
- **SECTION 4** provides an overview of the recommended prescriptive and administrative requirements to support the Framework's performance targets;
- **SECTIONS 5 AND 6** discuss the potential design and construction implications of the Framework for both building design and costs;
- **SECTION 7** provides a discussion of the next steps for implementation;
- **THE APPENDICES** provide the full details on all modelling inputs, targets, and costing for each archetype, as well as the Energy Modelling Guidelines and Resilience Checklist.

## 2. GLOBAL BEST PRACTICES IN ENERGY EFFICIENCY POLICY



A study and review of Global Best Practices in Energy Efficiency Policy (GBP) was completed for Toronto's City Planning Division in 2015 to understand the strengths and weaknesses of a range of approaches to implementing minimum building performance requirements. The study reviewed a selection of international best practices in energy codes and policies and provided a detailed assessment of 12 mandatory standards and seven voluntary programs (see Table 2). Each standard was assessed for its alignment with or support for key priorities for the City of Toronto, including:

- Use of consistent metrics
- Ease of review, compliance and enforceability
- Overall accuracy and simplicity
- Use of passive design strategies/comprehensive energy efficiency measures
- Use of design requirements
- Clear targets
- Transparency
- Peak demand/demand response
- Supports resiliency objectives
- Compatibility with site and district scale initiatives
- Does not limit creativity
- Addresses Toronto-specific issues, e.g. construction trends, climate, etc.
- Uses life cycle costing
- Links to long-term targets
- Sets a future target

Table 2: Review of energy efficiency standards

MANDATORY STANDARDS	VOLUNTARY STANDARDS
1. Denmark's BR10 Building Regulations 10	1. Architecture 2030 (USA & Worldwide)
2. Germany's EnEV2009 Energy Savings Ordinance	2. Minergie (Switzerland & Worldwide)
3. Norway's TEK10	3. Leadership in Energy and Environmental Design (LEED V4) (US, Canada, Worldwide)
4. France's RT2012 Thermal Regulations	4. Living Building Challenge (Worldwide)
5. England & Wales' Part L Conservation of Fuel	5. Passivhaus (Worldwide)
6. Seattle's Target Performance Path	6. Comprehensive Assessment System for Built Environment Efficiency (CASBEE)( Japan)
7. Vancouver's Building Bylaw	7. Building Research Establishment Environmental Assessment Method (BREEAM ) (UK & Worldwide)
8. California's Title 24 Part 6	
9. ASHRAE 90.1	
10. ASHRAE 189	
11. IECC International	
12. NECB National Energy Code for Buildings	

The report also reviewed research and practices that have demonstrated a discrepancy between the intended results of certain approaches to building performance (i.e. lowering energy use) and actual improvements in building energy performance – what is commonly referred to as the “performance gap”. In this section, the results and recommendations of this study are summarized to provide a foundation for understanding the changes proposed in the new Zero Emissions Buildings Framework.

## 2.1. APPROACHES TO BUILDING ENERGY PERFORMANCE

Based on the review conducted in the GBP report, two major approaches to requiring specific levels of building energy performance can be identified.

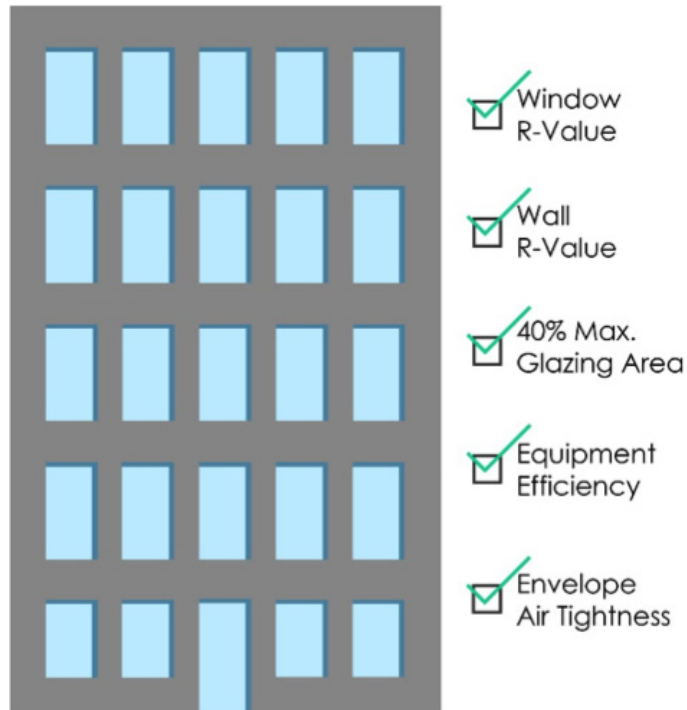

Figure 4: A reference building approach to building energy

**Prescriptive approaches** provide itemized lists of building design requirements for mechanical, electrical, and envelope systems that impact building energy use (Figure 4). Specific requirements can include, for example, minimum R-values for insulation or wall assemblies, caps on the total area of glazing, efficiency standards for mechanical systems, or maximum infiltration rates. Prescriptive approaches are often either the foundation of, or included in some way into, all modern energy codes including SB-10 of the Ontario Building Code (OBC), ASHRAE 90.1, and the National Energy Code for Buildings (NECB).

In contrast, **Performance-based approaches** focus on the overall performance of a building (rather than its component parts). This approach in turn uses two different methods: the use of a reference building, or the use of absolute performance targets. Both approaches require the use of energy modelling software to assess the predicted impact of different design strategies on overall building energy use.

First, the Reference Building approach requires design teams to develop a reference building (often defined using prescriptive elements) to assess the impact of different design strategies on a building's relative energy performance. The reference building approach is often expressed as a 'percent better than' approach, in that building designs are often required to achieve a set percentage improvement over the baseline reference building's performance (see Figure 5). This is currently the most commonly used methodology in Canada, used by the NECB, the performance path of the OBC, and the current version of the TGS.

Second, the Performance Targets approach sets one or more absolute energy use and/or emissions targets for different types of buildings. These are often based on the energy consumed in a building per unit of floor area expressed over time, and is most commonly expressed in terms of the building's Energy Use Intensity (EUI). This approach is more common in European building energy codes, as well as high performance building standards such as Passive House and Minergie. It is also being proposed as an alternate path in a future version of the NECB. Emission-based targets can also be used alongside, or in place of EUI targets; for example, in the form of a greenhouse gas intensity target (see next section).

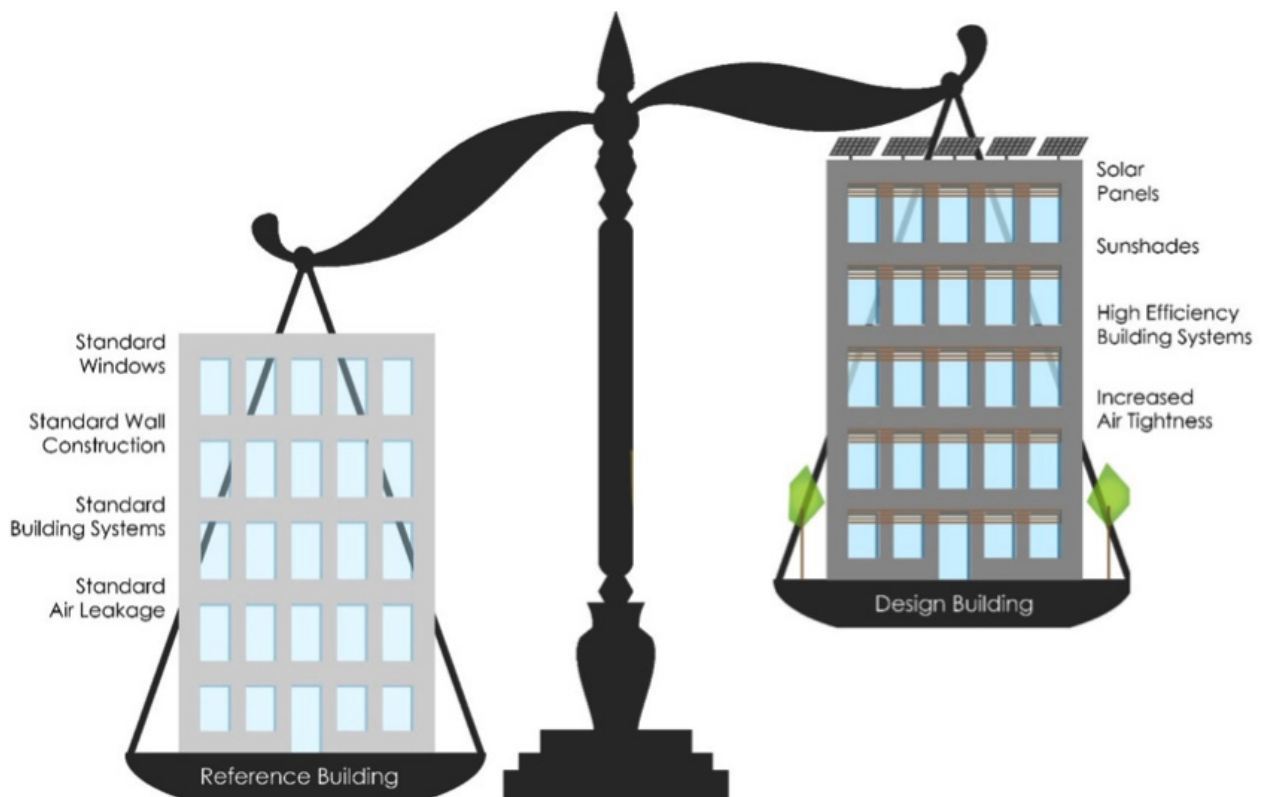

Figure 5: A reference building approach to building energy

## 2.2. MOVING TO A TARGETS-BASED APPROACH

*“...the targets-based approach has demonstrated positive results in Europe in actually reducing building energy use.”*

Overall, the review conducted in the GBP report found that while conventional energy standards in North America for commercial and multi-family buildings have become more stringent over time, these updates have not correlated to lower absolute energy use in new buildings. For example, a recent report that summarized the outcomes of a sample of buildings that met the requirements of the Toronto Green Standard showed little correlation between the performance requirement of the energy standard that a building complied with, and the amount of energy it was designed to consume.<sup>x</sup> Similarly, a study of multi-unit residential buildings in Vancouver showed no correlation between building age and actual energy performance.<sup>x</sup> Data from New York City’s energy benchmarking report affirm these trends, in that energy use in new buildings was found to have increased over time, both in intensity and absolute values, despite stricter energy efficiency standards.<sup>xi</sup>

This body of research collectively suggests that more conventional North American approaches to building performance (i.e. prescriptive or reference building approaches) have not been effective in lowering building energy use over time. While simple and easy to manage from a compliance perspective, the prescriptive approach is not scalable over time and has not demonstrated improved energy performance. It can moreover limit the creativity of the building industry by requiring specific design elements or components. Reference building or ‘percent better than’ approaches have similarly been found to have limited success in actually reducing energy use in buildings, and can furthermore create confusion among the industry as to what standard buildings must be designed to, as they are revised every few years. Finally, reference building approaches limit the ability to set clear targets over time, as the baseline continuously shifts.

In contrast, the targets-based approach has demonstrated positive results in Europe in actually reducing building energy use, and has been used in recent updates to select North American codes. The use of a performance targets approach also allows building owners and regulators to compare actual performance with designed performance, and to compare performance between buildings. The use of specific energy performance targets furthermore support a straightforward review and compliance process that simultaneously allows design teams an opportunity for creativity in the selection of building strategies. Finally, absolute performance targets are much better suited to transitioning the building development industry to zero energy and/or emissions over time, as ‘zero’ is itself an absolute target. Overall, recent research therefore indicates the value of selecting an absolute performance targets-based approach in actually lowering building energy use.



## 2.3. SELECTING METRICS

Where a performance-based approach to regulating building energy use has been selected, the identification of an appropriate set of metrics is a necessary next step. The review of global best practices revealed the use of five primary targets: four energy use intensity targets to incentivize lower energy use, and a fifth GHG emissions target has been shown to reduce carbon and other GHG emissions associated with building use. Each one is explained below:

**REGULATED LOADS** refer to the energy use that can be impacted by choices made on building design. This generally includes decisions on heating, cooling, ventilation, service water heating, and lighting, and can include service energy use, such as elevators. Measuring regulated loads excludes plug loads, and in doing so only considers the functions that a designer can more directly predict or control.

**TOTAL ENERGY DEMAND** is a measure of all energy used in a building. This includes the energy used by the building's basic mechanical systems, as well as its "plug" loads, or the energy used by appliances, electronics, and lighting. By offering a full picture of a building's energy use, a total energy demand target can encourage more efficient choices in the selection of all energy-related building components, including domestic hot water heating, space conditioning, building envelope strategies and appliances. Total energy demand is often measured as the total energy use intensity (TEUI) of a building, or the full amount of energy consumed in a building per m<sup>2</sup> of floor area per year (expressed in kWh/m<sup>2</sup>/year). A lower TEUI indicates a more efficient building.

**THERMAL ENERGY DEMAND** shows the total amount of energy that is required to heat a building to maintain a stable, pre-defined interior temperature, once all sources of heat loss through the envelope and passive heat gains from occupants or equipment are accounted for. Thermal demand is used by some of the most progressive building codes and voluntary standards, such as Passive House, which have demonstrated consistent energy savings over time. The use of a thermal energy demand metric requires designers to optimize passive design measures such as orientation, solar access and envelope before looking to mechanical solutions (see Section 5). This approach also reduces reliance on mechanical systems, which can lower incidences of operational inefficiencies or mechanical issues that affect overall building efficiency. High envelope efficiency represents a passive design solution that provides the co-benefit of boosting a building's resilience to extreme weather events. A lower Thermal Energy Demand Intensity (TEDI), expressed in kWh/m<sup>2</sup>/year, indicates a higher level of energy efficiency.



**PEAK DEMAND** is a measure of the highest possible energy use intensity of a building in a year. This metric is commonly used by designers to estimate the appropriate size of mechanical equipment and ensure building systems can meet demand. The inclusion of a peak energy demand metric can encourage ‘peak shaving’ measures, demand management strategies and sometimes on-site storage that reduce stress of the grid during weather extremes (either heat or cold).

**GREENHOUSE GAS INTENSITY (GHGI)** is a measure of the total amount of GHGs associated with a building’s energy use. It is different from the other metrics listed above, in that it converts the energy use of a building into GHG emissions using an emissions factor for the specific energy sources used by the building. In this way, it accounts for the performance of different fuels – for example, renewable sources of energy have a low carbon intensity, while natural gas has a higher carbon intensity. Using a GHGI metric therefore encourages the use of low carbon energy, on-site renewable energy, and energy efficient building envelopes and components. A low GHGI, expressed in kg/m<sup>2</sup>/year, indicates a building that emits fewer GHG emissions.

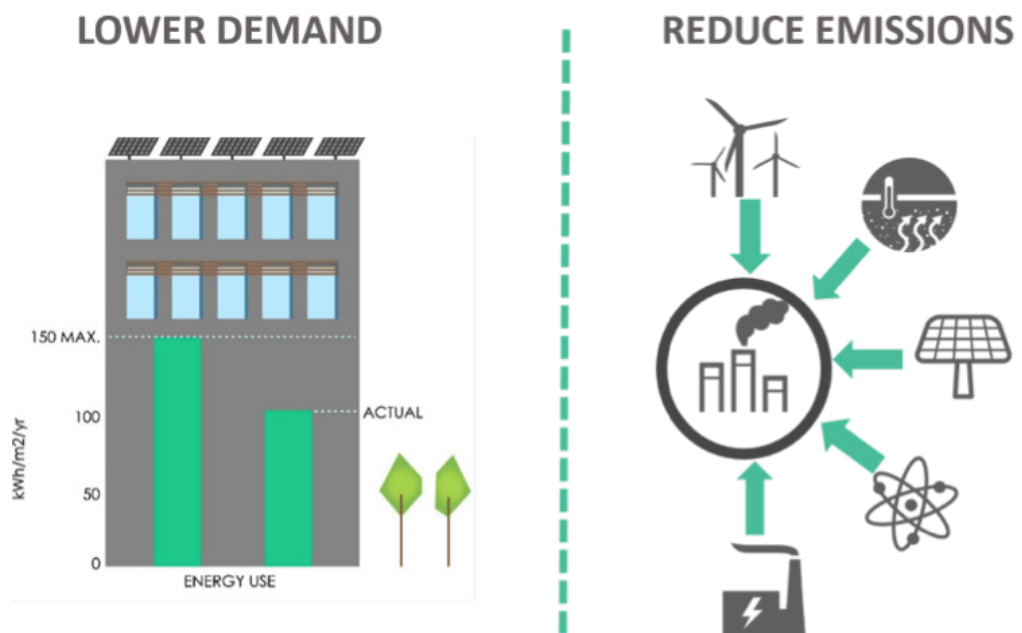

Figure 6: Using a combination of performance metrics helps to realize several goals simultaneously

While each of the above metrics can be used on their own, many leading standards have elected to use a combination of metrics to ensure different goals (e.g. lowering energy demand and reducing emissions, see Figure 5) are realized simultaneously.



## 2.4. PRESCRIPTIVE REQUIREMENTS

In addition to absolute performance targets, several best practice performance codes and standards across both Europe and North America also include a set of prescriptive requirements. Some areas in which specific requirements have been set include:

- Minimum efficiency standards for mechanical systems (e.g. HVAC);
- Maximum lighting power density values to increase energy efficiency;
- Heat recovery ventilation;
- Thermal bridging requirements;
- U-values for envelope components, such as walls, roofs or windows;
- Sub-metering protocols that require building loads to be segregated and metered individually;
- Higher building commissioning requirements; and
- Administrative requirements to verify air tightness.

Of these, the most common prescriptive requirements across all standards pertain to building envelope standards, equipment standards, lighting efficiency, and air tightness testing. Several codes and standards also required the verification of energy models to ensure consistency between submissions and the accuracy of data.

## 2.5. ESTABLISHING A PERFORMANCE PATHWAY

Finally, a common thread among best practice codes and standards for energy efficiency is the establishment of a pathway and stepped tiers to reach a final goal. A review of the leading energy efficiency codes and standards reveals the importance of developing long-term targets that steer the development of interim performance requirements. Setting an ambitious long-term GHG emissions or energy target, such as “zero energy” or “zero emissions”, provides an overarching framework for the development of the standard. It also gives the building industry a clear and predictable long-term pathway that in turn gives building designers and owners confidence in a city’s direction and as such accelerates innovation. To support the achievement of long-term new construction targets, interim milestones that lead up to the target date can also be developed. Periods of intermittent review and revision of the process and stringency of performance requirements can also ensure that targets remain commensurate with sectoral goals and industry capacities.

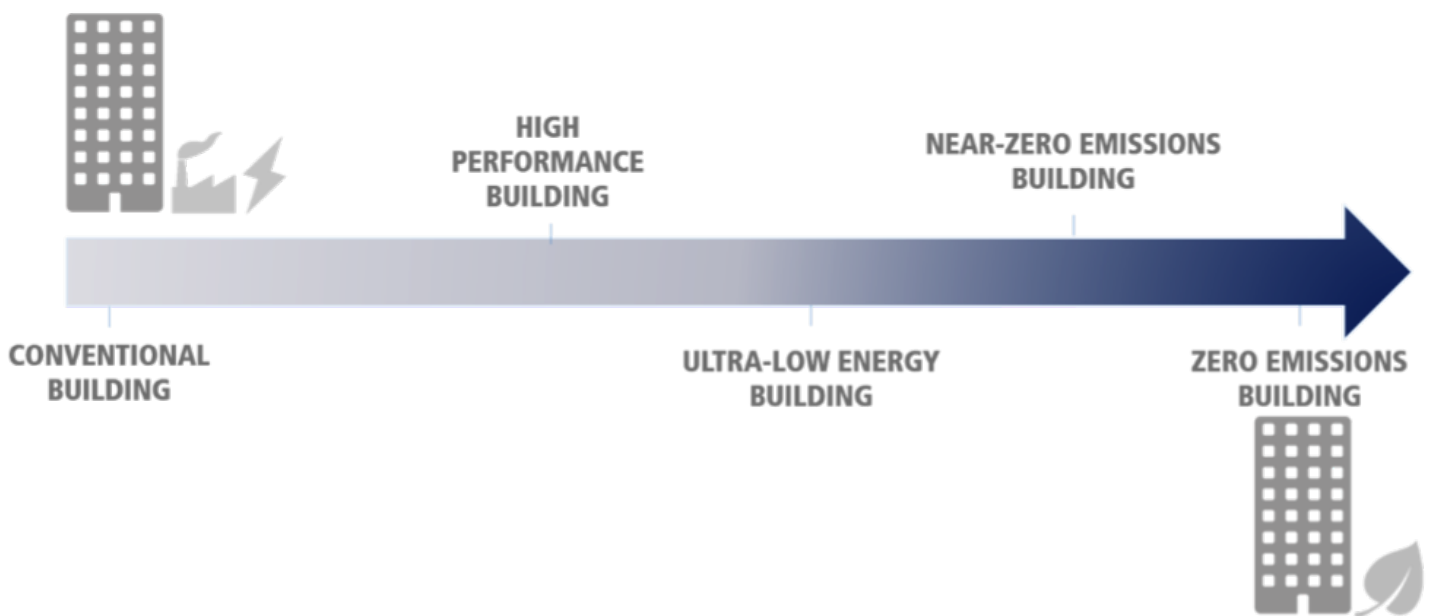

Figure 7: Establishing a pathway of improving building performance over time.

**“...a common thread among best practice codes and standards for energy efficiency is the establishment of a pathway and stepped tiers to reach a final goal.”**

## 2.6. SUMMARY OF RECOMMENDATIONS

The final result of the Global Best Practices report was a list of recommendations for the City of Toronto in designing a new approach to requiring building energy performance and for a TGS Version 3.0. Each recommendation was selected for its alignment with current best practices in energy efficiency policy, as well as with City priorities:

- Establish and commit to a long-term energy and GHG reduction target for new building construction to drive change in the development industry
- Use a performance target-based approach to regulating energy use and emissions to ensure the use of consistent metrics, allow for comparability between buildings, encourage creativity in the building industry, and ease review and compliance procedures
- Use a thermal energy demand target to encourage the use of higher quality building envelopes over improvements in equipment efficiency to support the use of passive design measures and improve building resilience
- Add a GHG intensity target to assist the City in meeting its GHG reduction goals
- Include a set of prescriptive requirements to supplement the targets, including:
  - Maximum lighting power densities to reduce peak demand and prevent the use of lighting in passive design
  - Sub-metering to provide information on how building energy is being used
  - Building commissioning to ensure buildings are operating as they were intended
  - Mandatory air tightness testing to identify areas of excessive heat loss in the building envelope
  - Third party review of energy models to reduce administrative burden and improve consistency
- Align these metrics with building labeling and disclosure requirements to ensure consistency and allow the City to track energy performance over time
- Establish a set frequency for updating energy and GHG performance requirements to provide predictability for the industry and ensure progress towards long-term targets

# 3. TORONTO'S ZERO EMISSIONS BUILDINGS FRAMEWORK



**“These metrics were selected to be used in unison to ensure a high level of building energy and emissions reduction performance in addition to encouraging high quality building design.”**

The recommendations crafted out of the review of international best practices outlined above formed the groundwork for a second phase of work conducted to develop a full Zero Emissions Building (ZEB) Framework for the City of Toronto. The way each recommendation has translated into a fully developed Framework, including specific methods used to develop them and the way they compare to Version 2.0 of the TGS, is explained in the following sections below.

## **3.1. METRICS AND TORONTO BUILDING ARCHETYPES**

The ZEB Framework represents a shift from the reference building approach used in previous versions of the TGS (i.e. percent better than OBC) to an absolute performance-based approach to reduce the performance gap between design and operations needed to meet Toronto’s climate targets. Based on the review of Global Best Practices in energy codes and standards noted above, three primary, mutually reinforcing metrics were selected for inclusion into the Framework:

- **THERMAL ENERGY DEMAND INTENSITY**, to ensure resilient buildings that improve both occupant comfort and thermal energy performance;
- **TOTAL ENERGY USE INTENSITY**, to ensure buildings with low overall energy-use and utility costs; and
- **GHG INTENSITY**, to encourage low-carbon energy sources and reduce building emissions.

These metrics were selected to be used in unison to ensure a high level of building energy and emissions reduction performance in addition to encouraging high quality building design. A Total Energy Use Intensity (EUI) metric has been added alongside Thermal Energy Demand Intensity (TEDI) and GHG Intensity to reduce overall building energy use and incentivize higher efficiency mechanical systems that will in turn reduce demand on the grid. TEUI was also determined to be a more appropriate metric than a regulated load metric as it is able to account for a building’s full energy demand, including the plug and process loads that can make up a significant portion of a building’s energy profile.

While a peak energy demand metric was also considered for inclusion, it was later excluded as a result of its high sensitivity to differences in energy modelling software. The use of one type of energy modelling software over another would have therefore created significant differences in the ease with which the target would have been realized.<sup>2</sup>

<sup>2</sup>.It should also be noted that peak demand is also included in the OBC as a key requirement, and as such will still be required as a key metric in any new construction.

Instead, peak energy demand in winter and summer are shown as outputs of energy modelling results to show how changes in energy and GHG performance may positively or adversely affect a building's demand on the electrical grid. Overall, the peak demand numbers demonstrated that despite fuel switches to electrical systems at higher tiers, summer and winter peaks are reduced via reductions in heating loads and electrical end uses. Such information is useful for utility planning and for sizing mechanical and electrical equipment. In the future, peak demand may also be used to more accurately estimate the carbon intensity of individual buildings based on increases in the marginal carbon intensity of the electricity supply.

Packages of building energy performance targets were developed for each metric for five new Part 3 building archetypes selected for assessment in collaboration with City of Toronto staff. Archetypes were developed to represent the five most common building types built in Toronto in 2016, and were created using "typical" building characteristics including building geometry, occupancy, and operational parameters. Together, the five building types account for a majority (87%) of the city's projected growth, and include:

- High-Rise MURB (i.e. concrete tower);
- Residential Mixed Use (i.e. ground floor retail with residential tower above)
- Low Rise MURB (i.e. 4-6 storey wood frame);
- Commercial Office; and
- Large Format Retail.

It should be noted that each archetype represents a generic building form, and as such does not take into account variables such as building orientation or particular site characteristics. Thus, while targets have assumed a set of generic shapes and a uniform distribution of glazing (i.e. windows), individual targets may be easier to achieve where specific buildings make use of better orientation and glazing strategies. Similarly, where building design incorporates features such as balconies, added glazing, or a high degree of building articulation (i.e. many joints between surfaces), targets will be more difficult to achieve. Given the composite nature of Residential Mixed Use projects, the archetype provided in this report is merely one example of how different uses can be mixed to provide different targets. Where a project has different proportions of residential, office and retail, targets must be adjusted based on a weighted average of the different uses.



## 3.2. SETTING TARGETS

The process of setting targets for each archetype was an iterative process of energy modelling, feasibility analysis, consultation with Advisory and Technical Committees, and revision. Packages of targets were developed for each of the five archetypes using a form of large-scale parametric analysis that simulates tens of thousands of design options and their impact on building energy performance. Combinations included building characteristics such as building form, wall and roof R-values, glazing ratios, and others were modelled to determine whether and how building designers could achieve higher levels of energy performance (see Appendix C for parametric modelling results).

The purpose of this analysis was to understand the potential of each building type to move towards an end goal of zero emissions, and identify stepped performance targets between the current state of practice in Toronto and the end goal. Using a parametric approach allowed the identified targets to be cross-referenced with a multitude of potential design solutions, which in turn demonstrated both the possibility and the flexibility for design teams to meet short, medium and long-term targets. Energy measure packages and targets were optimized for least capital cost premiums, market acceptance (i.e. to align with current building practices), and thermal resilience benefits.



Figure 8: Process of target development

Targets for each archetype were then verified to ensure the ability of Toronto's building and construction industry to reach each target using known building technologies. The results of the initial parametric analysis were presented in an interactive workshop to an Advisory Committee and industry stakeholders to obtain feedback and consensus on the overall trajectory and the feasibility of the proposed design solutions. Energy models were re-run and the performance targets were updated based on feedback, as well as updates to the energy modeling assumptions to more closely align with those made in the 2017 Ontario Building Code (Division 3). GHGI targets were determined using CO<sub>2</sub>e emissions factors derived from SB-10 (Table 1.1.2.2). Targets for each building archetype are presented in Sections 3.6 to 3.10, while the full set of targets developed for the Zero Emissions Buildings Framework are outlined in Appendix A.

### Modelled Design Options

- Building form (e.g. compactness, presence of balconies)
- Window-to-wall ratio (WWR)
- Wall R-values
- Roof R-values
- Window U-values (e.g. double/triple glazing)
- Fuel source (e.g. natural gas, electricity and district energy)
- Form of unit heating (e.g. electric baseboard, hydronic radiant systems)
- Efficiency of Heat Recovery Ventilators (HRV)
- Plug load efficiency
- Lighting efficiency
- Fuel source of corridor/common area ventilation
- Domestic hot water (DHW)



### 3.3. ASSESSING COSTS OF CONSTRUCTION

Part of the process of assessing the feasibility of the targets included an assessment of the likely costs associated with meeting each tier of performance. High-level estimates of costs associated with the changes to building design that would be required to meet each tier were calculated for both mechanical systems and envelope systems. This process involved first establishing a baseline cost of construction for each of the five building archetypes. For each one, baseline building attributes were selected to represent the most economical way a building could meet Ontario Building Code (2017) and TGS energy efficiency requirements. As such, baseline costs were based on the solutions that design teams most commonly use to meet the OBC, and not the specific prescriptive requirements of the OBC. For example, while the OBC's wall performance requirement is R18 (ft<sup>2</sup>F·h/Btu) and the maximum window-to-wall ratio is 40%, most high-rise residential projects typically demonstrate poorer envelope performance (between R3 and R7), and use window-to-wall ratios upwards of 50-60%. These projects still comply with the OBC and with TGS requirements by outperforming in other areas, such as mechanical system performance. Taking this approach to costing allowed for a more realistic picture of incremental capital cost increases that the industry will experience in attempting to meet the new TGS targets. Base construction costs for all other components were sourced from the Altus 2015 Cost of Construction Guide, and verified by the Technical Advisory Committee.

Following the development of the baseline, a series of costing packages were then created that could be used to meet the new TGS targets in the most cost-effective manner possible. While the results of the parametric analysis demonstrated the large number of available design solutions for achieving the levels of performance required by the new TGS, only one optimized solution for each level of performance was costed (per building type). Solutions that were chosen were selected based on the likeliness they would be pursued by a design team, which was in turn deemed a function of both the ease of their design and the lowest incremental capital cost. Packages for each tier were then compared to the baseline to allow construction costs to be expressed as a "percentage increase" in hard costs (i.e. materials and labour costs for all required upgrades). The premiums associated with rooftop solar installations were also modelled for Tier 4 MURB based on a 70% roof area coverage. While the premiums associated with solar installations were calculated for this tier, they were later removed to reflect the optional nature of on-site renewable energy requirements (see Section 4.1) and to avoid disproportionately raising the costs of Tier 4. However, solar premiums were shown to and vetted by the Advisory Committee members.

Details on the results of the costing analysis for each building archetype are discussed in Sections 3.6 through 3.10, with the full set of base costs assumed with each modelled package are presented in Appendix D.

## 3.4. MODELLING BUILDING RESILIENCE

Aside from their energy performance, different tiers of performance for both High-Rise and Low-Rise MURB were additionally modelled for their impact on building resilience to power interruptions under winter conditions. Three metrics were used to assess the resilience of buildings constructed to the different tiers of modelled performance:

- Temperature lows after 72 hours of disrupted power service
- Temperature lows after 2 weeks of disrupted power service
- Duration of emergency back-up fuel reserves.

Temperature decays after 72 hours and two weeks were modelled using a typical weather file for Toronto and simulating the effects of a power outage beginning January 24<sup>th</sup>. Outdoor temperatures over both the 72 hour and 2-week period reached a minimum of -19°C and averaged at approximately -7°C. This modelling exercise helped to demonstrate the varying thermal resilience of buildings constructed to meet different tiers of performance, or their ability to maintain liveable indoor temperatures in the event of a power outage or disruption in fuel supply for prolonged periods of time. Given Toronto's increasing vulnerability to extreme weather events, including winter blackouts, these modelled outputs are important to show how well MURB buildings constructed with better envelope performance are able to provide adequate shelter for longer periods of time than conventional buildings.

Similarly, modelled outputs for the duration of back-up fuel reserves helped to demonstrate the overall passive survivability of MURB constructed to meet tiers 1 through 4, or the length of time critical life-support services can be maintained. Back-up generation was calculated by measuring the energy use of the building systems identified in the City of Toronto's Minimum Backup Power Guidelines for MURBs over a period of 72 hours (see Appendix F). Such information is crucial to demonstrating the value of higher tiers of building performance, not only for reduced energy use and emissions, but for occupant comfort and safety as well.

Analyzing the impact of improved thermal performance (i.e. TEDI targets) for summer power outage conditions was less conclusive. Internal room temperatures were highly dependent on shading from adjacent buildings, as well as whether units had access to one exterior wall with operable windows, or two exterior walls with windows. Generally, modelling results indicated that some improvement to occupant comfort occurred during summer power outages, but that mitigation of overheating is largely reliant on architectural considerations that do not directly affect energy (e.g. shading, natural ventilation – see Section 5 for a discussion of relevant passive design strategies). Resilience to extreme heat events is addressed in the Climate Change Resilience Checklist for New Construction (see Appendix F).

### 3.5. A PATHWAY TO ZERO

The resultant set of stepped targets for each of the three metrics provides a pathway to move from current TGS Tier 1 and Tier 2 requirements to a “near zero emissions” level of building performance (see Figure 6). Four tiers of increasing performance were developed to reflect the need to update building performance targets every four years to reach the zero emissions target. The pathway recognizes that the procurement of some form of off-site renewable energy will be required to meet a zero emissions level of performance.

2018	2022	2026	2030
V3 Tier 1	--	--	--
V3 Tier 2	➤ V4 Tier 1	--	--
V3 Tier 3	V4 Tier 2	➤ V5 Tier 1	--
V3 Tier 4	V4 Tier 3	V5 Tier 2	➤ V6 Tier 1

} Off-site renewable energy procurement = Zero Emission Buildings

Figure 9: A Pathway to Zero Emissions Buildings

In the next sections, the full implications for each of the five building archetypes are described, including current approaches to realizing Tiers 1 and 2; the four tiers of increasing performance; key changes to building construction approaches that may be required by each tier; basic costs of construction; and the results of the resilience analysis (where applicable).

**“Four tiers of increasing performance were developed to reflect the need to update building performance targets every four years to reach the zero emissions target.”**

## 3.6 HIGH-RISE MULTI-UNIT RESIDENTIAL BUILDINGS



The minto775 building on King St West was the first building to achieve TGS Tier 2.

Under the current TGS, residential buildings meeting Tier 1 requirements for 15% better than the OBC (2012) are turning to mechanical solutions first, and using mid- to high-efficiency boilers and heat or energy recovery ventilators (HRVs, ERVs) in individual suites. However, envelopes are still performing poorly, with R-values in the range of R5 to R7. These R-values are reflective of the predominant use of a window-wall cladding solution and window-to-wall ratios of approximately 50% using double glazing.

Current Tier 2 projects are performing somewhat better with regard to the building envelope in using window-to-wall ratios down below 50%, increasing R-values to R8 to R10, and making use of high performance chillers, domestic hot water flow savings, and common area lighting savings. Neither Tier 1 nor Tier 2 buildings are likely accounting for all thermal bridging that occurs through the building envelope.

Table 3: Targets for High-Rise MURB

Tier	New TGS Targets			Overall % Change in Construction Costs*
	EUI (kWh/m <sup>2</sup> )	TEDI (kWh/m <sup>2</sup> )	GHGI (kgCO <sub>2</sub> e/m <sup>2</sup> )	
<b>TGS v2 T1 (SB 10 2017)</b>	190	77	26	N/A
<b>TGS v2 T2</b>	170	70	20	1.5%
<b>TGS v3 T1</b>	170	70	20	1.5%
<b>TGS v3 T2</b>	135	50	15	3.5%
<b>TGS v3 T3</b>	100	30	10	6%
<b>TGS v3 T4</b>	75	15	5	3.6%

\* Changes in construction costs were determined using a base building scenario that conformed to SB-10 (2017)

The following is a summary of what was determined to be the lowest cost strategies for achieving each tier. Note that innumerable combinations of strategies could be used to achieve similar results.

**NEW TIER 1 TARGETS** mirror those of the previous Tier 2, but with some notable changes. R-values now need to reflect all heat losses, including thermal bridging at interface details. The energy use intensity metrics that are now used are also based on absolute values, forcing designers to consider energy use that is not currently regulated by the OBC and therefore not reflected in current TGS performance.

**NEW TIER 2 TARGETS** require improvements to the building envelope, and will likely require the use of triple glazing, as well as 25% improvement in air leakage over a baseline ASHRAE 90.1-2013 value. Meeting the Tier 2 targets will also likely require reductions in corridor pressurization from a typical industry value of 30 cfm/ suite to 15-20 cfm/suite, and/or improvements to the efficiency of installed suite HRVs or ERVs from 65% to 75%. Further reductions to domestic hot water loads will also be required.



**NEW TIER 3 TARGETS** begin to require the use of certain high-performance products, such as high-performance triple glazing (~U-0.2) and HRVs or ERVs (>80% efficiency), and a fuel switch from gas to heat pumps on at least a proportion of the plant, make-up air, and/or domestic hot water loads. Additional domestic hot water loads and air leakage reductions of approximately 40% to 50% better than the ASHRAE 90.1-2013 baseline may also be required to meet Tier 3.

**NEW TIER 4 TARGETS** drive down the heating load even further, and require a high-performance envelope with an effective R-value of approximately 20. Windows must achieve a performance level equivalent to Passive House, and a 75% or greater reduction in air leakage with minimal use of corridor pressurization must be achieved. Targets will also likely require a full fuel switch and the use of heat pumps for the majority of plant, make-up air and domestic hot water loads. However, the GHGI target will allow for some use of natural gas, recognizing the need to deliver peak heating loads during design days and/or for domestic hot water top-ups.

Altogether, the new targets move High-Rise MURB from an 11% increase in energy savings over SB-10 (2017) for Tier 1, to a 61% increase over SB-10 for Tier 4. All targets and design solutions for new tiers of performance were extensively vetted by representatives of the building design and construction industry, including academics, energy modellers, developers, and regulators.

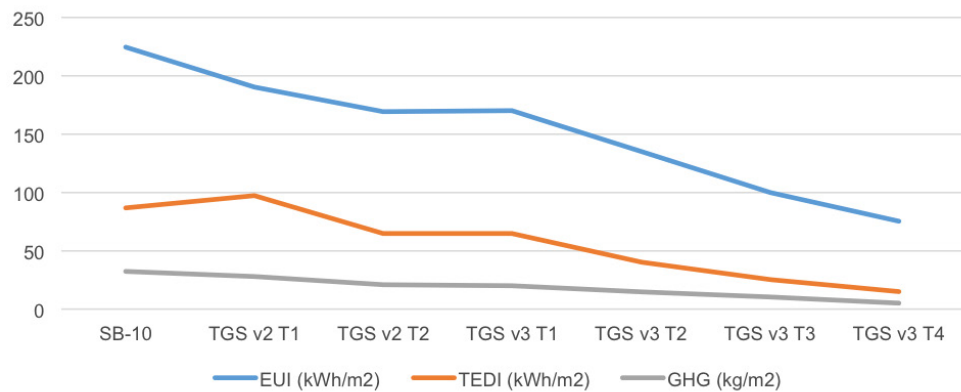

Figure 10: Target progression to near-zero emissions for High-Rise MURB

## BUILDING RESILIENCE

The results of the resilience analysis show that temperature lows after 72 hours of a power outage under winter conditions decrease steadily as the level of building performance increases (see Table 4). The benefits of the higher envelope performance of a Tier 4 building become apparent in looking at 2 week power outage temperature lows, which are significantly higher than either current TGS buildings, or lower tiers of the new TGS. Reduced energy demand also extends the lifespan of emergency backup fuel, from a factor 1.2 over the baseline to a factor of 1.8. Together, these modelling outcomes demonstrate the considerable benefit of improved building performance to the overall resilience of Toronto's building stock to extreme events and power outages.



The One32 Berkeley building developed by Concert Properties is a certified TGS Tier 2 building.

Table 4: Resilience of Tiers 1-4 for High-Rise MURB

Tier	% Energy Savings over SB-10	Peak Power (W/m <sup>2</sup> )	72h Power Off Winter Temp. Low (°C)	2 Week Power Off Winter Temp. Low (°C)	Emergency Fuel Factor (x baseline)
<b>TGS v2 T1 (SB-10 2017)</b>	N/A	11.1	9.9	0.9	1.0
<b>TGS v2 T2</b>	11%	9.7	13.5	5.8	1.2
<b>TGS v3 T1</b>	11%	9.6	13.5	5.8	1.3
<b>TGS v3 T2</b>	29%	9.6	14.6	7.6	1.4
<b>TGS v3 T3</b>	47%	11.0	17.0	14.0	1.5
<b>TGS v3 T4</b>	61%	11.5	19.7	18.3	1.8

### COSTS OF CONSTRUCTION

The premiums associated with the various tiers for High-Rise MURB are shown in Table 4, with more detail provided in Appendix D. Overall, costing results show an increase in expected premiums from 1.5% over the SB-10 baseline, to a maximum of 6% for Tier 3. However, a decrease in mechanical costs associated with Tier 4 lower the overall cost premiums from 6% to approximately 3.6% (see Appendix D). These results demonstrate the benefit of moving to higher tiers of performance to reduce the cost premiums associated with higher performance.



## 3.7. LOW-RISE MULTI-UNIT RESIDENTIAL BUILDINGS

The trajectory towards near zero emissions of the low-rise wood-frame MURB buildings is similar to that of the High-Rise MURB, with some small differences. Currently, neither HRVs nor ERVs are typically needed to meet current TGS Tier 1 requirements, as the use of a wood frame structure minimizes thermal bridging when compared to highly conductive concrete or steel structures. Thermal bridging is also minimized through the use of vinyl or fiberglass windows frames. Under the current TGS, Tier 2 buildings already likely require the use of HRVs or ERVs.

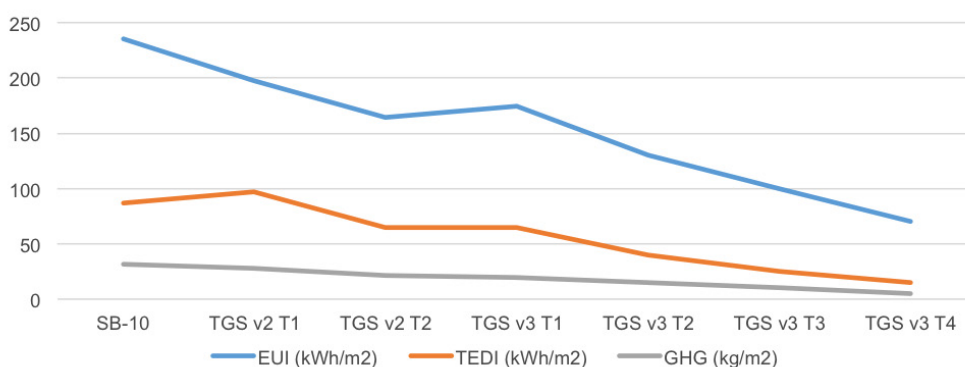

Figure 11: Target progression to near-zero emissions for Low-Rise MURB

The solutions for Low-Rise MURB also mirror those of the High-Rise archetype. Increasing levels of envelope and heat recovery efficiency will be required over time. A partial fuel switch for heating and domestic hot water loads will be required in Tier 3, while a near-complete full fuel switch will be required for Tier 4. The new package of performance targets move Low-Rise MURB from a 17% increase in energy savings over SB-10 (2017) for Tier 1, to a 65% increase over SB-10 for Tier 4. All targets and design solutions for new tiers of performance were extensively vetted by representatives of the building design and construction industry, including academics, energy modellers, developers, and regulators.

Table 5: Targets for Low-Rise MURB

Tier	New TGS Targets			Overall % Change in Construction Costs*
	EUI (kWh/m²)	TEDI (kWh/m²)	GHGI (kgCO2e/m²)	
<b>TGS v2 T1 (SB 10 2017)</b>	198	97	28	N/A
<b>TGS v2 T2</b>	165	65	20	0.4%
<b>TGS v3 T1</b>	165	65	20	0.5%
<b>TGS v3 T2</b>	130	40	15	2.1%
<b>TGS v3 T3</b>	100	25	10	5.1%
<b>TGS v3 T4</b>	70	15	5	4.9%

\* Changes in construction costs were determined using a base building scenario that conformed to SB-10 (2017)



## BUILDING RESILIENCE

Temperature lows during winter power outages modelled for Low Rise MURB show similar results as those for High Rise MURB, though with higher overall temperature losses. Substantial improvements in indoor temperatures can be seen in higher Tiers, though still below what may be considered an acceptable indoor liveable temperature. An increase in backup generation fuel potential, from a factor of 1.1 over the SB-10 baseline in Tier 1, to a factor of 1.6 in Tier 4. While these results are not quite as significant as those for High-Rise MURB, they nevertheless demonstrate that an improvement in building thermal resilience is achieved with the use of higher quality building envelopes.

Table 6: Resilience of Tiers 1-4 for Low-Rise MURB

Tier	% Energy Savings over SB-10	Peak Power (W/m <sup>2</sup> )	72h Power Off Winter Temp. Low (°C)	2 Week Power Off Winter Temp. Low (°C)	Emergency Fuel Factor (x baseline)
<b>TGS v2 T1 (SB-10 2017)</b>	N/A	12.4	5.2	-2.4	1.0
<b>TGS v2 T2</b>	17%	11.7	6.5	-1.5	1.1
<b>TGS v3 T1</b>	17%	11.6	6.5	-1.5	1.1
<b>TGS v3 T2</b>	34%	11.6	9.6	1.2	1.3
<b>TGS v3 T3</b>	49%	12.4	13.1	5.1	1.3
<b>TGS v3 T4</b>	65%	12.6	14.5	7.1	1.6

## COSTS OF CONSTRUCTION

Table 5 shows the estimated cost premiums associated with each tier, which shows an increase in cost premiums from 0.5% over the SB-10 baseline in Tier 2, to a 4.9% premium in Tier 4.



Figure 12: A 6-storey mixed use building designed by Cornerstone Architecture designed to achieve Passive House levels of performance. Source: Passive House Canada.

# 3.8 COMMERCIAL OFFICE BUILDINGS



Source: PEO.ON.CA

An average Tier 1-compliant solution for Commercial Office buildings today includes a standard curtain wall assembly with a 50% window-to-wall ratio, an effective R-value in the range of R5 to R7, and the use of double glazed windows. Building mechanical systems typically use a standard Variable Air Volume system (VAV) with mid- to high-efficiency heating, and OBC-compliant air or water-cooled chillers, depending on building size. Lighting savings over code are also common for Tier 1 compliant buildings. Buildings complying with current Tier 2 requirements are designing higher performing envelopes with R-values between R8 and R10, less than 50% window-to-wall ratio, better delivery of ventilation and higher performance cooling solutions.

**NEW TIER 1 TARGETS** and their associated requirements remain identical to those in the current TGS’s Tier 2 for Commercial Office Buildings.

**NEW TIER 2 TARGETS** see a drop in TEDI due to a move towards a dedicated outdoor air system with heat recovery and terminal heating and cooling (e.g. fan coils, radiant heating and chilled beam cooling). Tier 2 also requires an increase in envelope performance, particularly through the use of triple glazing and a 25% reduction in air leakage over the baseline value.

**NEW TIER 3 AND TIER 4** targets ratchet up the building envelope requirements, resulting in the use of high performance (i.e. Passive House) windows, R20 effective walls, increased lighting savings, higher performance heat recovery and/or demand control ventilation strategies, and a fuel switch from natural gas to electricity through the use of heat pumps. While Tier 3 targets do not require a fuel switch to meet the GHG targets, such a shift would take pressure off other electrical savings, such as lighting, fans and plug loads.



Figure 13: Target progression to near-zero emissions for Commercial Office

Altogether, the new targets move Commercial Office Buildings from a 13% increase in energy savings over SB-10 (2017) for Tier 1, to a 68% increase over SB-10 for Tier 4. All targets and design solutions for new tiers of performance were extensively vetted by representatives of the building design and construction industry, including academics, energy modellers, developers, and regulators.

Table 7: Targets for Office Buildings

Tier	New TGS Targets			Overall % Change in Construction Costs*
	EUI (kWh/m <sup>2</sup> )	TEDI (kWh/m <sup>2</sup> )	GHGI (kgCO <sub>2</sub> e/m <sup>2</sup> )	
<b>TGS v2 T1 (SB-10 2017)</b>	200	82	23	N/A
<b>TGS v2 T2</b>	175	70	20	1.7%
<b>TGS v3 T1</b>	175	70	20	2.3%
<b>TGS v3 T2</b>	130	30	15	3.1%
<b>TGS v3 T3</b>	100	22	8	3.0%
<b>TGS v3 T4</b>	65	15	4	2.2%

\* Changes in construction costs were determined using a base building scenario that conformed to SB-10 (2017).

## COSTS OF CONSTRUCTION

As can be seen in Table 7, the cost premiums for Commercial Office buildings are low overall, from a 2.3% increase in construction costs for Tier 1, rising to a 3% premium for Tier 3. What is especially interesting to note is that cost premiums associated with Tier 1 and Tier 4 remain essentially the same (2.3% to 2.2%). This slight decrease in premiums occurs despite the use of better performing windows at Tier 4, and as such is important for City staff to highlight to TGS applicants interested in becoming early adopters of higher tiers (see Appendix D).

## 3.9. RETAIL BUILDINGS

Retail buildings can take many forms, from the ground floor of a mixed-use building, to “big box” retail outlets (i.e. large format retail), to shopping malls. For the purposes of the costing analysis, a big-box retail archetype was assumed; however, all types of retail can meet the new TGS targets, with variations in their approach. The current baseline Tier 1-compliant Retail uses standard, natural gas-fired roof-top units. Current buildings typically achieve some lighting savings over code, and either some degree of ventilation heat recovery, demand-controlled ventilation, or higher efficiency heating equipment. Tier 2-compliant buildings currently require the use of heat recovery and/or demand controlled ventilation to meet their targets.

**NEW TIER 1 REQUIREMENTS** for Retail buildings are similar to those associated with Tier 1 levels of performance for other building types. There is no discernable change in performance from the current TGS’s Tier 2 level of performance; however, full accounting for envelope heat loss is incorporated into the performance metrics.

**NEW TIER 2 TARGETS** require an improvement in envelope performance, notably through the use of triple glazed windows and reduced air leakage, as well as a move to a dedicated outdoor air system with ventilation heat recovery.



Source: Ledcor

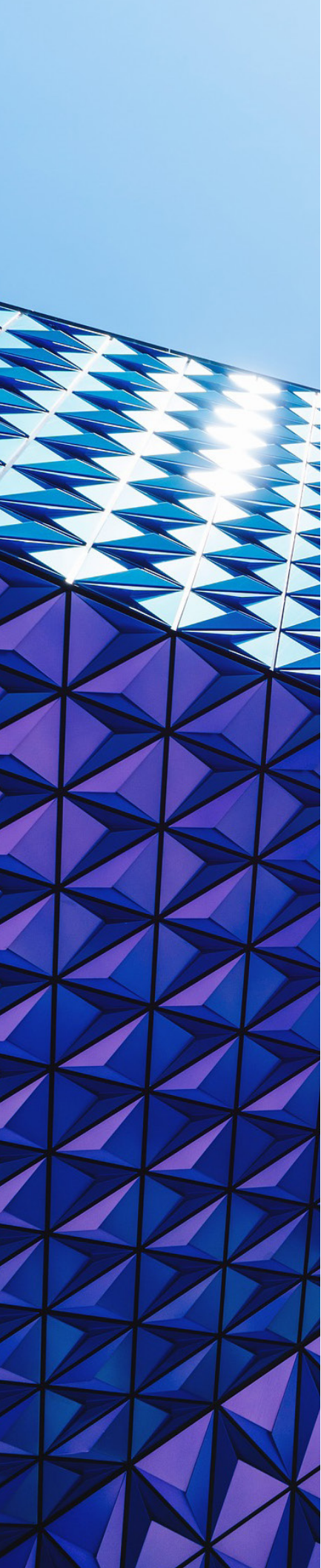

**NEW TIER 3 AND TIER 4 TARGETS** require higher window performance (i.e. Passive House levels of performance), as well as an increase in heat recovery efficiency and/or in the use of demand-controlled ventilation. A fuel switch to heat pumps is required in Tier 3 in order to meet the EUI and GHG requirements.



Figure 14: Target progression to near-zero emissions for Retail Buildings

Altogether, the new targets move Retail Buildings from an 11% increase in energy savings over SB-10 (2017) for Tier 1, to a 63% increase over SB-10 for Tier 4. All targets and design solutions for new tiers of performance were extensively vetted by representatives of the building design and construction industry, including academics, energy modellers, developers, and regulators.

Table 8: Targets for Retail Buildings

Tier	New TGS Targets			Overall % Change in Construction Costs*
	EUI (kWh/m <sup>2</sup> )	TEDI (kWh/m <sup>2</sup> )	GHGI (kgCO <sub>2</sub> e/m <sup>2</sup> )	
<b>TGS v2 T1 (SB 10 2017)</b>	190	75	24	N/A
<b>TGS v2 T2</b>	170	60	20	0.7%
<b>TGS v3 T1</b>	170	60	20	0.7%
<b>TGS v3 T2</b>	120	40	10	6.5%
<b>TGS v3 T3</b>	90	25	5	8.2%
<b>TGS v3 T4</b>	70	15	3	16.9%

\* Changes in construction costs were determined using a base building scenario that conformed to SB-10 (2017)

## COSTS OF CONSTRUCTION

The cost premiums associated with different tiers of performance for Retail buildings are shown in Table 8 and expanded in Appendix D. Cost premiums overall, and especially those associated with Tier 4, are greatest for this building type, as costs per square foot for retail buildings tend to be the lowest among the primary archetypes in Toronto. As such, increases in cost premiums have a relatively higher impact on overall cost. Retail construction is currently optimized to achieve the lowest first costs that are possible. The current OBC makes this a relatively easy achievement: by changing the methodology to include a performance target for TEUI, retail buildings must make more substantial investments in energy efficiency than other typologies.

## 3.10. MIXED USE BUILDINGS

Mixed use buildings are largely made up of components of the other three building types identified above (i.e. residential, commercial office, retail). Specific targets can be derived using an area-weighted average of the performance targets from the other building types, so that mixed-use targets are equitable and based on the unique make-up of any one mixed-use building project.

An example of how targets could be determined for a hypothetical mixed use building is presented in Table 9 below, in which a ratio of 90% high rise residential, 5% retail and 5% office is assumed.

Table 9: Sample targets for a Mixed Use Building

Tier	New TGS Targets		
	EUI (kWh/m <sup>2</sup> )	TEDI (kWh/m <sup>2</sup> )	GHGI (kgCO <sub>2</sub> e/m <sup>2</sup> )
<b>TGS v2 T1 (SB-10 2017)</b>	191	77	26
<b>TGS v2 T2</b>	170	70	20
<b>TGS v3 T1</b>	170	70	20
<b>TGS v3 T2</b>	134	49	15
<b>TGS v3 T3</b>	100	29	10
<b>TGS v3 T4</b>	74	15	5

Under the same hypothetical example, reaching the different performance tiers outlined in the Zero Emissions Building Framework would require similar changes to building components and technologies as noted for other building archetypes. This includes an increasing level of performance in the building envelope (e.g., higher R and U values), improved heat recovery efficiency in residential suites, and an eventual shift to heat pumps for some or all building loads.



Source: UrbanToronto.ca

## 3.11. MAJOR RETROFITS & OTHER BUILDING TYPES

The targets outlined for the five major building archetypes apply to new buildings, as well as all major building renovations – that is, any alteration or conversion of the building over 1000m<sup>2</sup>. “Major renovations” in this case refers to any major HVAC, envelope, or interior renovations that are extensive enough such that normal building operations cannot be performed while renovation work is in progress, and/or a new certificate of occupancy is required. Major renovations also extend to any proposed change of use of the building.

Further, while the archetypes presented above represent many of the major building types found across Toronto, there are of course a range of other building types that must be considered. Retail stores, food service outlets, hospitals, grocery stores, and light industrial buildings all make up Toronto’s building mix, and as such should also be addressed under the TGS. However, given their wide diversity of form, use, and specific energy characteristics, a set of energy (EUI, TEDI) and carbon (GHGI) targets have not yet been developed for additional building types. Specific targets for these building types may be developed over time; however, in the interim, a ‘percent better than’ approach can be used. This recommendation aligns with the current TGS (v2).

**FOR TIER 1**, a target of 15% better than current requirements for SB-10 must be achieved for all other building types.

**FOR TIER 2**, a target of 25% better than current requirements for SB-10 must be achieved.



## 4. PRESCRIPTIVE & ADMINISTRATIVE REQUIREMENTS



The review of other global standards for building energy performance described above revealed the importance of including prescriptive and/or administrative requirements alongside performance targets. While they do not necessarily set a specific performance target to be met, requirements for energy modelling, submetering, air tightness testing, commissioning, and improved data collection and reporting have been found to encourage higher levels of compliance and correlate with improved building performance. Others, such as specific requirements for renewable or district energy, can help to support additional priorities, such as the reduction of peak demand on the grid.

The process of selecting a series of complementary prescriptive requirements was informed by both the Global Best Practices in Energy Efficiency Policy report, as well as consultation with Advisory and Technical Committee members. Specific requirements were selected to align with additional City of Toronto priorities and to help ensure that building performance targets will be achieved. Additional requirements were either updated from earlier versions of the TGS or recommended for inclusion into the next version of the TGS, and fall under the following categories:

- Renewable Energy (updated)
- Airtightness Testing (new)
- Building Commissioning (updated)
- Submetering (updated)
- Building Labeling and Disclosure (new)

While the addition of maximum lighting power density requirements were recommended in the Global Best Practices report, they have not been included as a prescriptive requirement in the Zero Emissions Buildings Framework. The rationale for this exclusion is that lighting power densities are already necessarily addressed when modelling building performance to achieve the Total EUI targets. Minimum lighting power density requirements have also been recently updated in the OBC and already guarantee an acceptable minimum level of energy efficiency.

In addition to these prescriptive requirements, two additional administrative requirements have also been included into the proposed Framework:

- Updated Energy Modelling Guidelines, to improve consistency and demonstrate compliance, and
- The Climate Change Resilience Checklist for New Development, to encourage the construction of resilient buildings.

The rationale for the selection of each of these requirements, as well as their specific inclusion into the Zero Emissions Building Framework, are outlined below. The full set of prescriptive requirements proposed for inclusion to support the performance based targets are outlined in Appendix E.

# 4.1. RENEWABLE ENERGY GENERATION

As noted in the Introduction, the City of Toronto's 2009 Sustainable Energy Strategy has set a number of targets for electrical demand reduction, natural gas consumption reduction and renewable electrical and thermal energy generation for 2020 and 2050. These targets were issued in response to the City's commitment to reducing reliance on fossil fuels and GHG emissions by 30% below 1990 levels by 2020, and by 80% of 1990 levels by 2050.

Currently, the City of Toronto currently boasts approximately 40 MW of renewable electricity installed (via solar PV systems). Continuing to add building-scale sources of renewable energy (as well as site and neighbourhood-scale installations) should continue to be encouraged to help meet the City's targets, address climate change mitigation, and help ensure energy does not become a limiting factor for growth and prosperity in Toronto. Local generation of renewable energy also increases the resilience of the built environment by reducing electrical demand and providing back-up power in the case of area-wide grid failures, as electricity is generated on-site.

In TGS Version 2.0, Tier 1 requirements were issued for all City-owned buildings with a gross floor area greater than 600m<sup>2</sup> to install renewable energy devices that could supply a minimum of 5% of the building's total energy load. Tier 2 buildings were given the option to 1) design and install on-site RE systems to supply at least 1% of the building's total energy load from solar PV, solar thermal, and/or wind energy sources, or 2) to supply at least 20% of the building's total thermal energy load from geo-exchange.<sup>3</sup> Under the new Framework, these requirements will be increased to further support the City's goals of reducing GHG emissions, reducing demand on the grid, and improving building resilience.

---

3. Geo-exchange is not typically defined as a primary source of renewable energy, but has been included as a renewable energy option in order to encourage the use of high efficiency electric-based heating technologies (e.g. ground source heat pumps).



Under the new Framework, Tier 1 buildings should include provisions to be “Solar Ready”.

**SOLAR READINESS** refers to the design of a building in such a way that solar photovoltaic and/or thermal systems can be easily installed at some point after the building has been constructed. The rationale behind solar readiness is that while the installation of solar technologies may not be economical at the time of construction, it may become more so in the future, so long as the building’s design and structure can accommodate them. Solar Ready principles issued by the City of Toronto’s Energy Efficiency Office include the following:

- Designate an area of the roof for future solar PV and/or solar thermal and make it structurally sound to support it;
- Provide two conduits from the roof to main electrical room (size of conduit to be determined based on maximum potential PV system size), and mechanical room (size of conduit to be determined based on maximum solar thermal system size);
- Designate a 2m x 2m (6ft x 6ft) wall area in the electrical and mechanical rooms for future solar electrical/thermal equipment (meters, monitors, etc.) controls and connections; and
- Where possible place the HVAC or other rooftop equipment on the north side of the roof, to prevent future shading.<sup>xii</sup>

It should also be noted that the City of Toronto’s Green Roof Bylaw requires all new commercial, institutional and large residential developments with a minimum gross floor area of 2000m<sup>2</sup> and height of 6 storeys or greater to construct a green roof. The larger the building, the larger the area of available roof space must be covered by a green roof. Areas for renewable installations are considered allowable deductions from total green roof area, making the use of green roofs and solar PV/thermal compatible within the Bylaw.

The Tier 2 optional requirement has been updated from the 1% required in the previous version of the TGS in order to help support Toronto renewable energy targets and increase building resilience to power outages. The target of 5% was determined to be feasible for all modelled building archetypes by exploring the costs of rooftop solar installations on 70% of the roof area of the High-Rise MURB archetype (see Section 3.3). As the MURB represents the most constrained building type, it was determined that all other building types would be able to reach the 5% renewable energy target. The addition of on-site renewable energy will assist building in meeting their GHGI targets.

A list of sources of on-site renewable energy has been provided in Table 10, which reflect available energy sources and allow flexibility to those buildings with lower solar generation capacity (e.g. shaded buildings). Plans for renewable energy generation should be verified at the Site Plan Approval stage.

Table 10: Potential Sources of On-site Renewable Energy

Energy Source	Description
<b>Photovoltaic panels</b>	Composite panels that convert solar energy into electricity, to be used within the building or exported to the grid
<b>Solar thermal systems</b>	Solar thermal collectors that convert solar energy into heating air or water for use within the building
<b>Biogas systems</b>	Fuel cells that use biogas to convert hydrogen and oxygen into electricity
<b>Biofuel systems</b>	Fuels produced directly or indirectly from organic material and combusted for the production of thermal energy or electricity*
<b>Wind systems</b>	Building- or site-integrated wind turbines that convert wind energy to electricity
<b>Geexchange systems</b>	The use of ground source heat pumps that use electricity to harness heat from the ground under and/or surrounding a building

*Guidelines for allowable biofuels under the LEED v4 credit for Renewable Energy Production should be followed when selecting specific requirements.*

## 4.2. LOW-CARBON THERMAL ENERGY NETWORKS (DISTRICT ENERGY SYSTEMS)

Approximately 240 MW of thermal renewable energy is currently derived from deep lake water cooling in Toronto, which additionally avoids 61 MW of electricity demand, equivalent to approximately 6% of the total electrical demand of the downtown core. The City of Toronto has additionally identified 30 potential low-carbon, thermal energy networks (i.e. district energy systems) in Toronto, which are primarily located in designated growth areas such as the Downtown, Centres, and along the Avenues.

Like on-site renewable energy, the development of these low-carbon networks has been identified as a key strategy for meeting GHG reduction targets and fostering local economic growth. They provide opportunities to achieve significant emissions reductions at relatively low cost when compared to individual buildings by virtue of both network effects and economies of scale. Connecting to a low-carbon thermal energy network removes the need for individual building heating and cooling systems, which can be expanded as new buildings are constructed and demand increases, making such networks a scalable and cost-effective means of providing heating and/or cooling (see Figure 11). District thermal energy networks can also provide a more reliable source of heating, cooling, and sometimes electricity, ensuring the comfort of building occupants during periods of extreme weather or power failures.

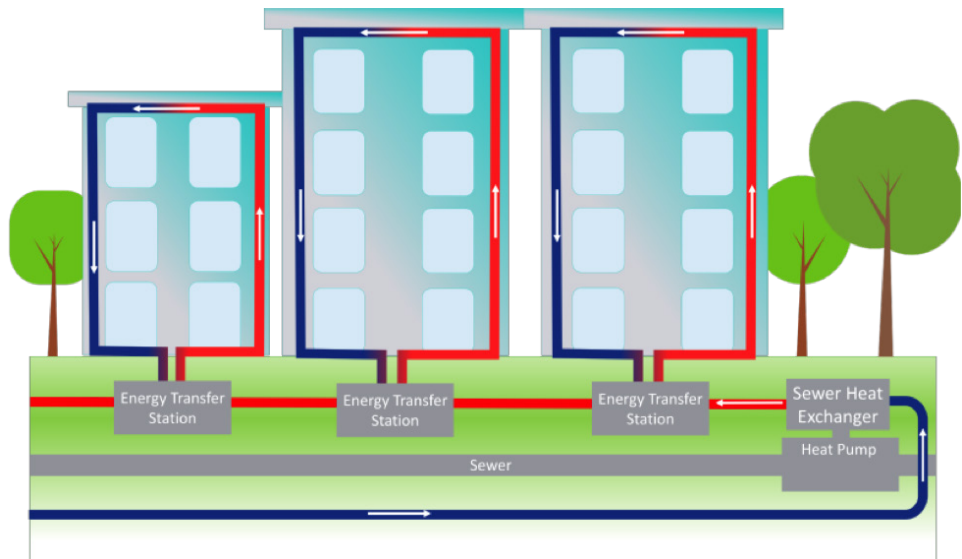

Figure 15: Low-carbon/renewable thermal energy networks (district energy systems) require little infrastructure within buildings, and can achieve high GHG reductions at relatively low cost (Source: City of Toronto)

Under the current version of the TGS, there is no incentive for a new development's connection to a low-carbon thermal energy network (i.e. district energy system). Under the new targets-based framework, connection to district energy systems is now recognized and rewarded in that the achievement of GHGI targets is eased wherever that system uses a low-carbon source of energy (e.g. deep lake water cooling, geo-exchange, solar thermal, waste heat recovery, biofuels, etc.). Design teams will be obliged to recognize the emissions intensity of different energy sources when modelling the energy and emissions performance of a building. The emissions intensity of specific sources of energy are outlined in SB-10 2017 (CO<sub>2</sub>e Emissions Factors, Table 1.1.2.2). However, information on the specific carbon intensity of a given fuel source of a district energy system must be obtained directly from the providers, or a reputable source. In addition to this overarching incentive, Tier 1 should include a provision for buildings to be "District Energy-Ready" wherever a district thermal energy system exists or is slated for development.

***"Under the new targets-based framework, connection to district energy systems is now recognized and rewarded in that the achievement of GHGI targets is eased, but only where that system uses a low-carbon source of energy."***

Akin to solar readiness, “District Energy-Ready” refers to the design of a building in such a way that future connection to a district energy system is facilitated. Key elements of a District Energy-Ready building have already been outlined in the City of Toronto’s Design Guideline for District Energy-Ready Buildings, and include:<sup>xiii</sup>

- The ability to supply thermal energy from ground level;
- Adequate space at or below ground level for a future energy transfer station;
- An easement between the mechanical room and the property line to allow for thermal piping;
- Two-way pipes placed in the building to carry the thermal energy from the thermal energy network to the section in the building where the future energy transfer station will be located;
- A low temperature hydronic heating system that is compatible (i.e. large temperature differential, or “Delta-T”) with a thermal energy network in order to reduce the pipe sizes and associated valves, fittings, etc.; and
- Appropriate thermal energy metering.

These readiness requirements may be increased in future versions of the TGS to eventually require a certain percentage of solar energy generation, and/or provisions for thermal energy network connection.

Tier 2 buildings should be required to connect to a low-carbon district energy system wherever one exists or is slated for development. As in Tier 1, requirements for Tier 2 may also be increased over time to require a larger percentage of building energy supplied by on-site renewable energy sources.



## 4.3. AIR TIGHTNESS TESTING

The practice of testing a building's air tightness refers to the measurement of the rate of air leakage from a building envelope. The testing process is conducted by sealing up all a building's openings (e.g. operable windows and doors) and pressurizing the interior spaces to determine the building envelope's resistance to air leakage. The result of air tightness tests can help to identify any major sources of air leakage and/or deficiencies that should be addressed prior to occupancy, thereby improving building energy performance.

Requiring air tightness testing prior to occupancy has been found to be an effective means of ensuring that buildings are performing as they have been designed. The practice of mandatory air tightness testing is already fairly established in Europe as a means of verifying and ensuring the performance of building envelopes, and has more recently been introduced by several jurisdictions in North America, including the Cities of Vancouver and Seattle, and the State of Washington. However, mandatory air tightness testing is not yet considered standard industry practice in Canada. No specific levels of air tightness are currently required by the Ontario Building Code for Part 3 buildings, and it has not yet been included into the TGS as a requirement. Therefore, one of the key recommendations for the Zero Emissions Buildings Framework is the inclusion of a mandatory air tightness test for all **Tier 2** buildings.

In Toronto, the absence of any larger scale requirements for air tightness testing has resulted in a dearth of information on the actual rates of air leakage through typical building envelopes. By requiring an air tightness test, the City of Toronto will be better able to monitor building performance over time, thereby improving our understanding of typical levels of airtightness that are being achieved, and the appropriate measures to take to requiring better envelope performance.

Air tightness testing requirements should initially be limited to a request for proof that a test has been completed, without requiring a specific level of performance. Specific requirements can follow the precedent laid out in the Seattle Energy Code (Section 1314.6)<sup>xiv</sup>, and should include:

- Proof of a full contract with an air tightness testing contractor at the pre-approval stage;
- Submission of an Air Tightness Testing Plan at SPA that outlines how and when the air tightness test will be conducted, and;
- Submission of a final Air Tightness Test Report at occupancy.



Limiting initial requirements for a test only to be conducted, without requiring a specific level of airtightness to be achieved, will allow the building industry the necessary time to build capacity for airtightness testing, while still providing information of typical air leakage rates of Toronto buildings. Results from the City of Seattle have demonstrated that even where a specific level of air tightness has not been requested, simply requiring an air tightness test can incentivize owners to improve the quality of construction of building envelopes and thus the energy performance of buildings. As in Seattle, the US Army Corps of Engineers' Air Leakage Test Protocol for Building Envelopes can also be used as a guideline for whole building air tightness testing in Toronto buildings.<sup>xv</sup>

Modelling required to show compliance for all three performance targets under the new Framework (TEUI, TEDI and GHGI) rely heavily on estimates of air leakage through the building envelope. As such, requiring a specific level of air tightness can help to ensure that building actually achieve their energy performance targets. Indeed, Seattle has now begun to move toward a maximum air leakage rate (2L/s per m<sup>2</sup> of façade area @ 75 Pascals), as well as specific leakage rates for individual building components (e.g. windows). Over time, the air tightness requirement in the TGS may be similarly extended to a specific level of air tightness to help ensure that Toronto consumers receive high quality buildings that perform as they have been designed to, and that provide an adequate level of thermal comfort to building occupants at reasonable cost.



## 4.4. BUILDING COMMISSIONING

Building commissioning is an important process of quality assurance that ensures building systems operate as designed. At a basic level, commissioning processes typically include a review of the design intent of a building as set out in the Owner's Project Requirements, and an evaluation of whether and how they have been met. More extensive commissioning processes can also be used to ensure that building equipment has been installed, major building systems are tested, adjusted, and balanced, maintenance and operational materials are adequate, and/or operations staff have received adequate training on the operations and maintenance of building systems. Commissioning is increasingly important in higher performance buildings, particularly as newer systems or technologies can require finer tuning to ensure their proper function. Higher level commissioning requirements are currently included in energy codes in the City of Seattle and the State of California, and was recommended in the development of the BC provincial step code. However, they are not currently required in the Ontario Building Code (OBC).



Source: ACEEE

The current version of the TGS includes requirements for fundamental building commissioning at the Tier 2 level. Applicants are required to provide a signed declaration template with the retained commissioning agent and a copy of the commissioning plan, or report available at the time of Tier 2 certification. The requirement is aligned with the LEED NC 2009's prerequisite for Fundamental Commissioning of Building Energy Systems, the LEED EA Enhanced Commissioning credit, and the National Institute of Building Sciences' Building Commissioning Guide as examples of best practices for commissioning.

Increasing and extending these commissioning requirements to both Tier 1 and 2 buildings over time would assist the City of Toronto in ensuring that new construction achieves its new energy performance targets. Modelled energy performance is contingent on expected performance of mechanical and envelope systems that are in turn based on expectations of proper installation and operation. As with air tightness testing, building commissioning acts as a means of verifying that these targets will be met, as well as a form of consumer protection, in that it helps to ensure that occupants receive well-functioning buildings that perform as they were intended to. It will also provide the City of Toronto with a means of managing and enforcing compliance.

Under the new framework, it is recommended that Tier 1 include a new provision for buildings to engage a commissioning agent and undertake fundamental commissioning. The LEED v4 Fundamental Commissioning and Verification credit should be used as the basis for complying with this requirement. Additional requirements may include:

- Proof of a full contract with a third-party Commissioning Agent (i.e. with no prior involvement in project design) at the pre-approval stage, and
- Submission of a Building Commissioning Plan, including the contact information of the Commissioning Agent that has been retained, the approximate timeline of the commissioning process, and details on the process of commissioning itself, including what systems will be tested and how.



One of the key recommendations for the new ZEB Framework is the inclusion of an enhanced commissioning for all Tier 2 buildings. Enhanced commissioning requirements include all of those covered in fundamental commissioning practices, but with several additional requirements. Among these, an important dimension of enhanced commissioning is the inclusion of the Commissioning Agent earlier on in the design process in order to verify key documents, help avoid problems, and facilitate dialogue between owners, designers, and contractors. Enhanced commissioning also often includes the development or verification of user and systems manuals that help to ensure all systems are operated optimally. As with Tier 1 buildings, the LEED v4 Enhanced Commissioning credit should be used as the basis for achieving compliance. Specific requirements over and above those for Tier 1 buildings include:

- Submission of a Commissioning Report at the occupancy permit stage that outlines what testing procedures were used, any operational testing that is still outstanding, and a final balancing evaluation. This should also include a narrative of how the Owner's Project Requirements were met.

Definitions and procedures for fundamental and enhanced commissioning are based in the updated LEED v4. Commissioning practice must follow ASHRAE Guideline 0-2005 and Guideline 1.1-2007 (consistent with LEED), and be performed by a certified commissioning agent only. Commissioning Agents must additionally be independent, i.e. may not be an employee of the design or construction firms working on the project. This ensures a fair and unbiased review of building systems.

Specific building systems that should be commissioned under the new TGS requirement could include:

- HVAC systems: all "complex systems" and systems with economizers, as well as "simple systems" with over 140 kWh cooling or 175 kWh heating;
- Lighting and daylighting systems: 20 kW installed lighting overhead, or more than 10 kW with daylight or occupancy controls;
- Domestic hot water systems: 60 kWh capacity;
- Building envelopes; and
- Renewable energy systems.

## 4.5. SUBMETERING

Submetering refers to the installation of devices capable of metering energy usage at various points after the primary utility meter. Submetering allows building managers to monitor energy use in real time, seasonally, and annually at more granular scales. This in turn provides an understanding of energy consumption trends both within a building, and in comparison with other similar buildings types. Identifying key areas and periods of energy use helps to pinpoint possible mechanical issues, as well as the design of strategies to reduce energy consumption and optimize building performance.

Under the TGS Version 2.0, submetering is an optional condition for buildings seeking Tier 2. It requires the installation of in-suite thermal energy meters on all heating and cooling appliances in residential buildings, above and beyond existing requirements for individual suite meters for electricity use. Similarly, both thermal energy meters for heating and cooling appliances and electricity meters are also required at the individual tenant scale in multi-tenant commercial/retail buildings. All meters must conform either to the Canadian Standards Association (CSA) Standard C 900 Heat Meter Standard or to the European Committee for Standardization (CEN) Standard EN 1434. The current TGS also recommends the use of the International Performance Measurement and Verification Protocol (IPMVP) to guide energy savings strategies.

A requirement for energy submetering provides several benefits. First, the need for submeters is predicated on the notion that to manage energy use, it must first be measured. Managers or tenants face serious challenges in reducing building energy use in instances when they have little idea of where energy is actually being used. By segregating different building uses or areas, a more complete picture of building energy use can be obtained and efforts to reduce energy can be targeted more effectively.

Further, monitoring individual appliance or tenant energy use helps to “close the loop” on design by giving building designers, owners and managers an understanding of how building components are performing relative to their modelled performance. Lower than predicted performance can be an indication of several potential issues, from poor installation to improper operations and opportunities for tenant education. Providing a basic level of energy use information is key to begin to identify areas of building performance that require improvement, and help to set future targets for building performance across the city. Submetering will also help to support energy benchmarking and reporting requirements under the Province of Ontario’s energy benchmarking and disclosure legislation, which requires building owners to report their annual energy consumption to the Province (see Section 4.6) While the provincial regulation only requires energy and water consumption reports using master utility meters, submeters can help to clarify uses between uses and/or tenants. As such, requirements for submetering should be considered for inclusion for both tiers under the new Framework.



Source: cyberswitching.com

It is recommended that Tier 1 Buildings require the installation of thermal energy submeters at a floor-by-floor scale for commercial buildings, and for defined use (e.g. parking, amenity areas, and common areas) for residential buildings. Tier 2 Buildings should be required to install thermal energy meters at the individual suite or tenant level.

## 4.6. ENERGY BENCHMARKING AND DISCLOSURE

Building energy benchmarking is a process through which building owners and/or managers are required to track and report their building's energy performance. Benchmarking has been increasingly recognized over the last several years as a necessary component to green building programs, in that they allow for an assessment or evaluation of the success of different policies or measures over time. Given the possibility of discrepancies between modelled and actual building performance noted earlier in this report, accurate data on building performance can improve the City's understanding of how buildings are actually performing, where capacity building efforts should be directed, and how future targets should be set.

In 2015, the City of Toronto and the Province of Ontario jointly initiated a process to require energy reporting and benchmarking by large commercial and multi-residential buildings (i.e. over 50,000 square feet) across the province. The following year, enabling legislative amendments to the province's Green Energy Act (Bill 135) were passed and a draft benchmarking regulation was issued, with a final regulation issued in February 2017 (See: Reporting of Energy Consumption and Water Use). Beginning in 2018, building owners will be required to report building energy (and water) consumption on a yearly basis using ENERGY STAR® Portfolio Manager, a standard benchmarking program developed in the United States and managed in Canada by Natural Resources Canada.

As the Province of Ontario has already made energy reporting and benchmarking a requirement, an additional requirement under the TGS is not necessary. However, one of the central issues with energy benchmarking and reporting requirements is that building attribute data entered by the owners is often incorrect. This data is especially challenging to acquire in a building's operational phase, but is readily available during the permit process. By requiring applicants to register their buildings into Portfolio Manager at the permit stage, the City of Toronto can assist building owners in reporting their data more accurately later on. Building owners should be required to submit proof at the occupancy stage that the building or property has been registered with ENERGY STAR® Portfolio Manager.

To ensure that new buildings' energy performance data is tracked and shared with the City of Toronto over time, the above requirements should be accompanied by proof, either via a screen shot submitted to the City of Toronto or by verifying the account status, that the City of Toronto has been named as a "Reviewer", allowing them to view building data. Proof that utilities (e.g. electricity, natural gas, water) have been linked to the account will ensure that accurate utility data is being used. While the provincial regulation requires all energy consumption data to be shared with public agencies, these added measures can add a measure of redundancy while the regulation is in its early stages of implementation.

## 4.7. ENERGY MODELLING GUIDELINES

High performance buildings often require some form of energy modelling to evaluate the complex technical and design elements that they use and understand how a building is likely to perform. To ensure consistency and equity in complying with codes and standards, some jurisdictions have developed energy modelling guidance packages to assist applicants in complying with requirements. In Toronto, the City Planning Division has been requiring design stage energy modelling reports as proof of compliance for TGS energy performance requirements since 2010. This requirement alone has catapulted the energy modelling industry in Toronto and has ensured that energy efficiency in building design is considered early on in the building and site design process.

Energy modelling has since become standard practice both in Toronto and beyond its boundaries, and is the foundation for achieving and demonstrating compliance with the new stepped targets framework. The City of Toronto's Energy Modelling Guidelines provide standardized inputs and software requirements for the as-designed and as-constructed energy modelling reports required for Tier 1 and 2. These reports are reviewed by the City's Energy Efficiency Office (EEO), who also implement the utility-based incentive programs offered to cover energy modelling

costs or to pay for construction savings. Either the EEO or a hired third-party evaluator are also responsible for inspecting building systems at occupancy stages for Tier 2 projects.

The shift to an absolute performance targets approach will require some procedural changes, i.e. the way building performance is assessed. To streamline the process of administration, support applicants, ensure best modelling practices are used, and ensure compliance, an updated set of Energy Modelling Guidelines have been provided. The new guidelines now include clarification on key considerations when modelling building performance targets including:

- Definitions and calculations for TEUI, TEDI, and GHGI;
- SB-10 emissions factors for calculating GHGI;
- How on-site renewable energy and district energy connection can help to meet targets;
- Acceptable energy modelling software;
- Standardized inputs for occupancy and other schedules, domestic hot water, process loads, and infiltration;
- Specific component requirements, e.g. heat recovery ventilators;
- Accounting for envelope heat loss, including thermal bridging; and
- Considerations for mixed use buildings.

Providing such energy modelling guidance ensures the use of best modelling practices and facilitates the process of assessing and enforcing building performance both before and after occupancy.

## 4.8. CLIMATE CHANGE RESILIENCE CHECKLIST

As noted in the Introduction, the City of Toronto has begun to explore methods of improving the resilience of its built stock to the impacts of climate change. As Toronto's climate warms, building designers will need to account for changes in seasonal temperatures, precipitation patterns, and the frequency and severity of extreme events. Expected changes in weather patterns and extreme weather events projected by climate change scenarios for the City of Toronto were summarized in Toronto's Future Weather and Climate Driver Study, which provided a series of climate projections from 2040 to 2049. Key predictions for Toronto's future climate include:

- An increase in projected average summer temperatures by 3.8°C
- An increase in extreme daily minimum temperatures by 13°C
- An increase in the number of days above 20°C from 133 to 160



- An increase in the number of days above 0°C by 16%
- An increase in the number of “heat waves” (i.e. events with more than 3 consecutive days of temperatures greater than 32°C) from an average of 0.57 occurrences per year to 5 occurrences per year
- An increase in the number of days requiring air conditioning from 10 to 180
- A decrease in the number days requiring extra heating from 440 to 60
- Slightly more precipitation overall, with the highest increases expected for the months of July (+80%) and August (+50%)
- A smaller number of storm events, but an increase in the amount of precipitation in these events
- A threefold increase in extreme daily rainfall in the month of June.

In light of these changes, the City of Toronto has developed a means of helping applicants to consider the impact of a future climate on the well-being of their occupants. While voluntary standards are emerging, these are not yet fully developed and take substantial time to administer and verify compliance. In lieu of specific resilience requirements, the City of Toronto has opted for a checklist approach to encourage building design teams to consider the key impacts of climate change on their design and incorporate measures to improve building safety and occupant comfort during extreme events. The checklist covers the following areas:

- Energy performance, including modelled TEUI, TEDI, and peak energy demand intensity;
- Modelling assumptions, including assumptions on temperature minimums/maximums, extreme heat events, and flooding events;
- Thermal resilience and safety, or the measures used to reduce the impact of heat waves;
- Back-up generation capacity, as well as any measures that have been taken to reduce reliance on the grid;
- Flood mitigation, including any measures that have been taken to reduce the impact of heavy rainfall events; and
- Manager and tenant preparedness measures during extreme events.

The complete Climate Change Resilience Checklist for New Construction can be found in Appendix F.



## 5. IMPLICATIONS FOR BUILDING CONSTRUCTION



Altogether, the new Zero Emissions Buildings Framework for Toronto includes a number of changes to the way building energy performance must be modelled, measured, and enforced. New energy performance targets, coupled with prescriptive requirements that help to ensure building performance achievements are realized, incentivize a shift in the way buildings must be designed and constructed. The shift from a reference building ('percent better than') approach to the use of absolute energy performance targets incentivizes several changes in building design. Typically, the reference building approach used by most Ontario codes and standards tends to encourage design strategies that focus on incremental improvements in the overall performance of the building, where efficiencies are most easily gained through mechanical and electrical systems. This focus on improvements in mechanical systems in turn results in an emphasis on improving the efficiency of active systems that require energy to function. Active system technologies are selected on the basis of how well they can meet building requirements, such as occupant thermal comfort and indoor air quality, while ensuring a sufficiently high level of energy efficiency.

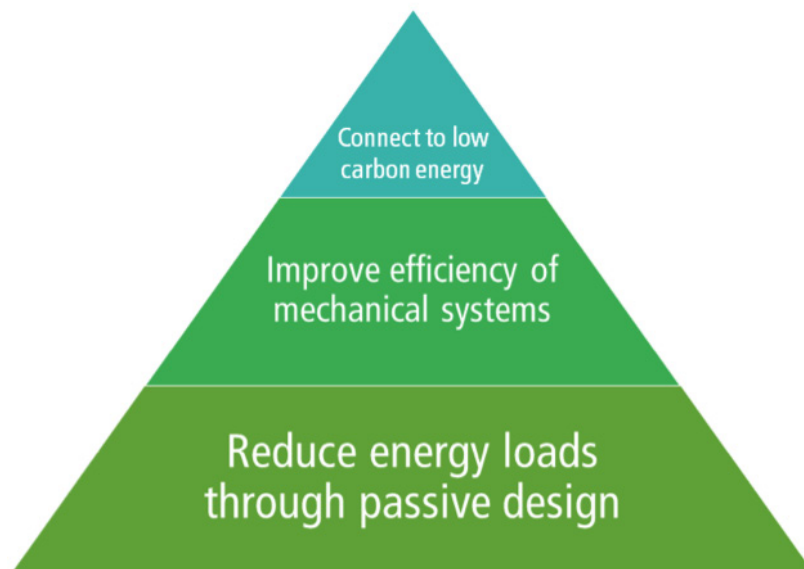

*Figure 16: Low-carbon building design hierarchy*

However, the use of a Total Energy Use Intensity (TEUI) target requires building designers to consider and achieve higher levels of overall building energy efficiency. The use of a Thermal Energy Demand Intensity (TEDI) target also moves design away from an emphasis on mechanical system efficiency, towards a prioritization of reducing thermal energy demand. Of course, the improved efficiency of mechanical systems is still important in reaching specific energy performance targets.

However, the inclusion of a TEDI target compels building designers to explore opportunities to reduce thermal energy loads prior to improving mechanical systems. The use of a TEDI targets that lowers thermal energy demand also helps to increase building resilience to periods of extreme heat, cold and/or power outages. Buildings designed with thicker building envelopes, lower glazing ratios, lower incidences of thermal bridging, or other highly efficient building strategies help to maintain liveable indoor temperatures with less energy and for longer periods of time under power outages. Buildings with lower TEUI and

superior thermal performance also require less back-up fuel during periods of power outages, lengthening the lifespan of back-up generation reserves or energy storage. Finally, the use of a Greenhouse Gas Intensity (GHGI) target drives a shift towards connection to low-carbon sources of on- or off-site renewable energy.

These three driving forces can be seen in terms of a hierarchy of building design principles, in which energy loads are reduced first, energy efficient systems are selected second, and low-carbon energy is procured third (Figure 13). In the next sections, the details of how this hierarchy can be put into practice, and its benefits for building design, are explained.

## 5.1. PASSIVE DESIGN STRATEGIES

“Passive design” refers to the process of designing and constructing buildings in such a way that both thermal energy requirements are minimized, and the comfort of building occupants is improved. Passive design strategies maximize the use of free, ambient sources of energy to light, heat, cool, and ventilate building spaces, reducing the need for “active” mechanical systems that use energy and cost money to heat, cool, and circulate air through buildings. Besides improving energy performance, the benefits of passive design extend to improved occupant comfort, reduced operational costs, lower electricity and heating bills, and fewer incidences of moisture and mould growth.

Five major strategies can be employed in building design to achieve passive energy performance, and should be used in tandem to realize their full potential.

**BUILDING ENVELOPE DESIGN** A durable, high-quality building envelope that prevents air and moisture from entering interior spaces is the most effective way of improving a building’s energy performance, and often the most difficult and expensive component of a building to retrofit later on. As such, it is important to maximize the potential of the building envelope at the time of construction, as well as good solar orientation and massing, to ensure high building performance at relatively low cost. An airtight building envelope with high-performance insulation and windows ensures that unwanted heat gains and losses are minimized. Good building envelopes also extend the lifespan and durability of a building by slowing or preventing the entry of moisture into the building’s structure or components.

### Elements of Passive Design:

- Orientation
- Compact massing and form
- Exterior shading
- Thermally broken balconies
- Continuous insulation
- Window frame detailing
- Natural ventilation
- Material selection



Good envelope design includes the need to minimize incidences of thermal bridging, or the creation of pathways for heat to move from the inside of the building to the outside. Thermal bridges are created when structures such as balconies, beams, or window frame details run from the building interior to exterior. These bridges can be “broken” using measures such as continuous insulation, thermally-broken balconies, and careful window detailing. Opportunities for thermal bridging can additionally be minimized by ensuring building design prioritizes compact form and minimizes the use of complex junctions in the building envelope. A reduction in wall-to-window ratios and use of building envelope components with higher R-values (e.g. windows, walls, and roofs) also help to improve building thermal energy performance and achieve lower TEDI targets. Green roofs can also act as extra layers of building insulation that reduce building heat losses.

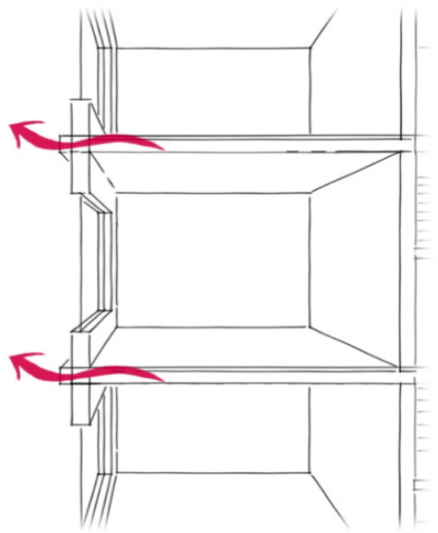

*Figure 17: Thermally unbroken slab edges and other features of the building façade provide ‘bridges’ that conduct heat out of the building.*

*Figure 18: Complicated junctions and variations in the building façade provide additional pathways for heat to escape the building, and should be minimized.*

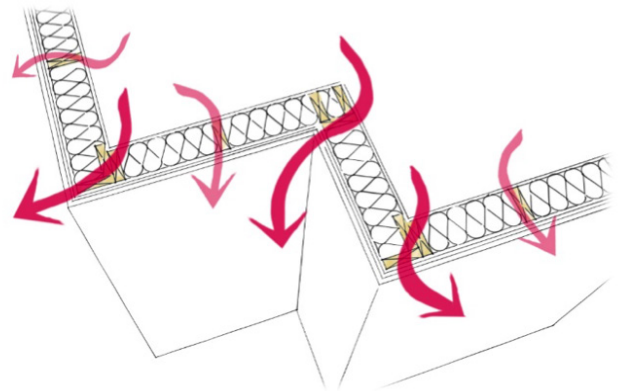

**PASSIVE HEATING** Passive solar gains, as well as internal gains from occupants and/or process loads, are all factored into the calculation of a building's TEDI. A building can be passively heated by collecting the thermal energy of the sun into interior spaces. In northern climates, this effect is achieved by properly orienting the building to the south and installing windows on the south-facing façade of the building to maximize heat gains in cooler months when the sun is lower in the sky. Well-insulated, airtight envelopes also prevent heat from escaping the building. As such, addressing thermal bridging and building airtightness is important to maximize passive heating. Improving a building's ability to harness incoming solar radiation will help to achieve lower TEDI targets by reducing the need for active mechanical systems that use energy to heat the building interior. Passive heating strategies are also important to improving a building's resilience to power outages in the winter months, in that interior temperatures can be better maintained in the absence of mechanical heating. Where electrical energy is used to heat the building, passive heating strategies can also help to reduce TEUI.

*Figure 19: Capturing incoming solar radiation helps to passively heat building spaces, lowering a building's TEDI. Proper window sizing and placement helps to ensure that solar gains are maximized without risking overheating in the summer.*

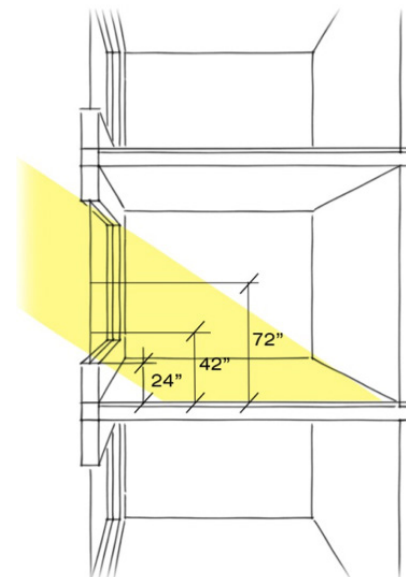

*Figure 20: Compact form helps to minimize thermal bridging through the building envelope*

**PASSIVE COOLING** Passive cooling is achieved by preventing and/or removing unwanted heat gains in warmer summer months to keep interior spaces at a comfortable temperature. Unwanted heat gains are minimized through the careful sizing and placement of windows, as well as external features such as shades, overhangs, and balconies to reduce incoming solar radiation. Deciduous trees planted on the south and west facades can reduce incoming solar radiation in the summer months and allow sunlight in through leafless branches in the winter. Light-coloured materials or vegetation on the building's exterior can also reduce the absorption and re-radiation of heat from the building, reducing the urban heat island effect. All of these strategies help to reduce cooling loads in the summer, reducing overall TEUI and helping to reduce demand on the grid during periods of high demand for cooling. All appurtenances (i.e. exterior structural and architectural details) are factored into the calculation of cooling loads; however, external factors (e.g. trees) are not generally included into modelling calculations.

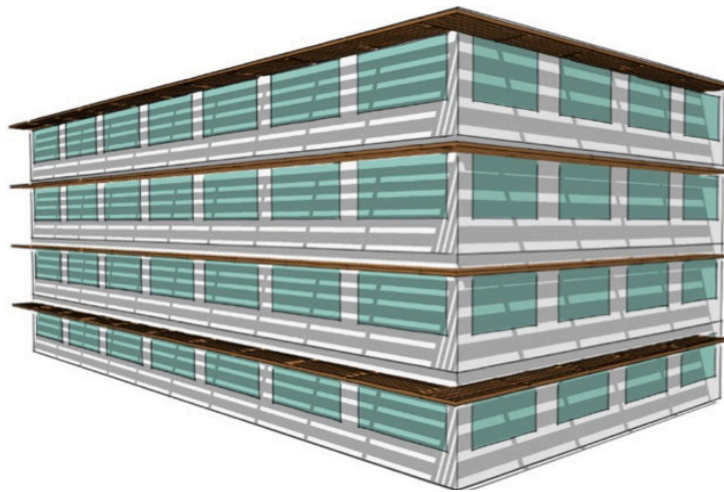

Figure 21: Installing shading devices over windows helps to minimize incoming solar gains in the summer months

**PASSIVE VENTILATION** Passive ventilation refers to the use of a natural flow of air to exchange stale, unwanted air with fresh air from the outside of a building. This process can occur through one of two means: cross-ventilation, in which air is moved across adjacent or opposing windows or openings in a unit or on a floor, or through stack ventilation, in which convection moves air through vertically stacked windows or spaces such as elevator shafts.

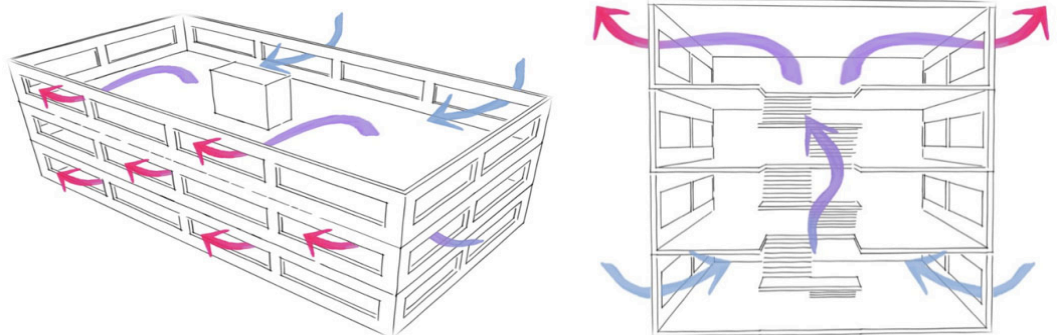
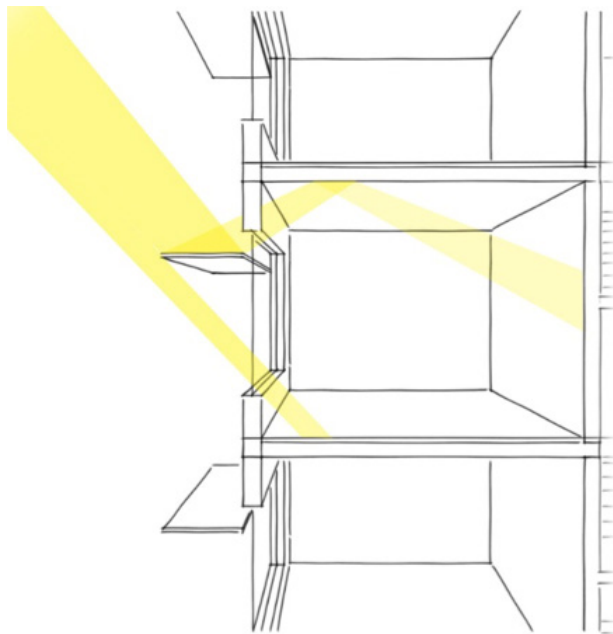

Figure 22: Cross ventilation (left) and stack ventilation (right) can be achieved through the appropriate placement of windows and operable windows to use incoming fresh air to move warm, stale air out of a building.

Processes of natural ventilation can also be used to facilitate passive cooling by removing warm air and replacing it with cooler outdoor air. Overnight, natural ventilation can be used to remove heat that has accumulated in the building throughout the day. A well-insulated envelope and carefully placed windows can also impact a building's cooling potential. Buildings can be oriented to maximize local ventilation potential, while exterior vegetation can help to cool and clean incoming outdoor air. Passive ventilation strategies work to help reduce demand for mechanical ventilation and therefore help to achieve TEUI targets.

**DAYLIGHTING** Daylighting refers to the use of natural light from the sun and reflected light from exterior surroundings to light a building interior. This strategy reduces the need for artificial, electric lighting, and can dramatically reduce a building's overall electricity consumption, thereby helping to achieve TEUI targets. Daylighting can also reduce energy requirements for space cooling through the elimination or reduction in the number of heat-generating light fixtures. To achieve this strategy, sensors can be placed around building perimeters to turn off overhead lighting when natural daylight is sufficient, and turn them back on in the evening or during cloudy periods. However, careful design is needed to maximize the daylighting potential while minimizing the risk of overheating due to overexposure to solar radiation.

**“Daylighting refers to the use of natural light from the sun and reflected light from exterior surroundings to light a building interior.”**



*Figure 23: Light shelves can help to gather and reflect incoming solar radiation and help to light interior spaces without overheating.*

## 5.1. HIGH EFFICIENCY MECHANICAL & ELECTRICAL SYSTEMS

Once passive design benefits have been maximized, mechanical solutions can be scaled to provide for remaining building needs. For example, higher efficiency HVAC systems can be achieved by selecting boiler and/or chillers that are responsive to anticipated operating conditions, and that incorporate high efficiency components such as pumps, fans, and motors.<sup>xvi</sup> In general, heating and cooling systems are more efficient when they minimize the difference between system operating temperatures and the acceptable space comfort temperatures, use water as the primary energy carrier, and operate independently from ventilation systems.<sup>xvii</sup>

To improve the efficiency of ventilation systems, ventilation rates can be lowered to reduce energy use while ensuring a high level of air quality and occupant comfort. Systems that use heat recovery ventilation (HRV) and energy recovery ventilation (ERV) are increasingly used to improve heating system efficiency by using waste heat from exhausted indoor air to heat incoming fresh air, reducing the need to heat indoor spaces. The efficiency of other processes, such as elevator operations or plug loads can also be improved through the selection of high efficiency components and appliances. System efficiency in general can also be improved by ensuring proper installation, commissioning, maintenance, and operations procedures are followed.

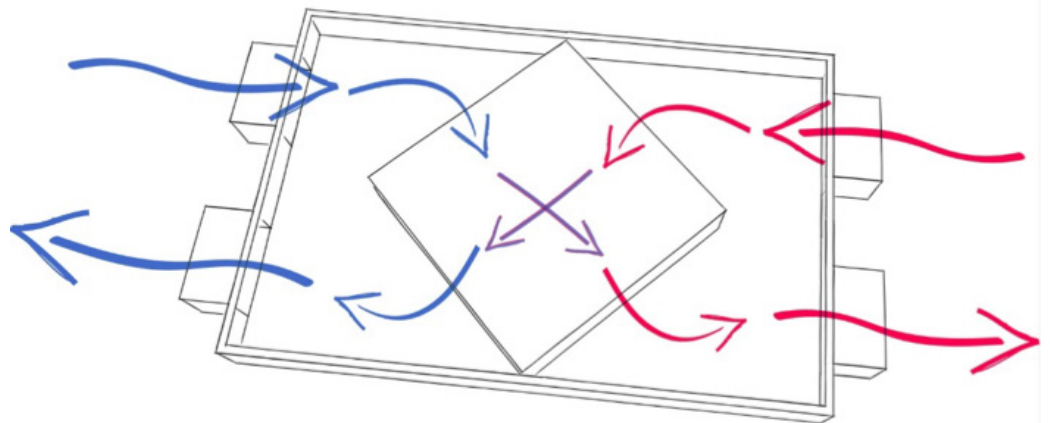

Figure 24: Heat Recovery Ventilators (HRV) recover the heat energy from stale air prior to exhausting out the building and use it to warm incoming air.

## 5.2. LOW-CARBON ENERGY SOURCES

Finally, while TEDI and TEUI performance targets will incentivize the use of passive design measures and lower energy use overall, the actual source of fuel used to meet any remaining building energy can be addressed using carbon intensity targets, or GHGI. Building design in Toronto typically draws on the use of either utility-provided electricity, and/or natural gas boilers to provide thermal energy (i.e. heat and hot water). By adding an emissions target, building designs will necessarily be required to consider the emissions intensity of different fuel sources, including both electricity and thermal energy. As GHGI performance targets are increased (i.e. lowered), a shift to the use of heat pumps as the primary heating system for new buildings will be encouraged and eventually required.

The achievement of carbon targets can be reached, or at least supported, by connecting to either a low-carbon source of district energy (where available) or to renewable energy generated on-site via solar photovoltaic (PV) panels, solar hot water systems, building-scale wind turbines, or the combustion of imported biomass or biofuels.

As tiers are increased over time, buildings in denser urban cores or that have high plug or process loads may need to procure an off-site form of renewable energy to meet the 2030 target. Off-site low-carbon energy can be sourced from standard utility offerings, such as hydroelectricity or utility-scale wind and solar, but can be procured from a range of other sources as well. Some of these include:

- District energy systems (connected to low-carbon energy sources);
- Community solar projects;
- Power Purchase Agreements that connect buildings to new sources of renewable energy;
- ‘Virtual’ Power Purchase Agreements that allow buildings to purchase renewable energy generated outside the local grid area;
- Legal arrangements that indirectly connect buildings to renewable energy, such virtual net metering agreements; and
- The purchase of Renewable Energy Credits (RECs).<sup>xviii</sup>

The connection to low-carbon sources, either on-site or off-site, will help to contribute to Toronto’s long term renewable energy generation and emissions reduction targets.



## 6. IMPLICATIONS FOR BUILDING COSTS



As outlined in Section 3, a full costing analysis for each tier of building performance was conducted in order to determine the feasibility of each target based on the likely costs associated with meeting them. A baseline cost of construction was established using building attributes selected to represent the most economic means of meeting both OBC (SB-10, 2017) and TGS (v.2) requirements. Baseline attributes were chosen based on the solutions that would most likely be selected by a design team, and/or sourced from the Altus 2015 Cost of Construction Guide and verified by the Technical Advisory Committee. As a part of the costing analysis, the percent of the capital cost premiums that could be covered by Toronto's Development Charge Refund were also calculated.

The results of this analysis demonstrated marginal construction cost premiums for lower tiers of performance (i.e. Tiers 1 and 2) in most building archetypes – from 0.5-3.5% increases over the baseline cost of construction for Low-Rise and High-Rise MURBs, to 2.3-3.1% for Commercial Office buildings. Construction premiums for Commercial Retail buildings vary more widely, with a 0.7% increase for Tier 1 and 6.5% for Tier 2. Premiums for High-Rise and Low-Rise MURB reached a maximum of 3.6% and 4.9%, respectively, over the baseline cost of construction for Tier 3 levels of performance, and only 3% for Commercial Office Tier 3.

What is particularly important to note is that cost premiums actually declined for the High Rise MURB, Low Rise MURB, and Commercial Office archetypes when moving from a Tier 3 to a Tier 4 level of performance. In the MURBs, these cost declines can be attributed to the decrease in mechanical costs associated with moving to Tier 4. The cost decline in Commercial Office building premiums may be partially explained by the shift from a high performance curtain wall using spray foam to a lower cost precast concrete system. These benefits of moving to a higher level of performance should be highlighted to applicants considering the early adoption of higher tiers, and supported with commensurate levels of support (see Section 7).

Costing analyses demonstrated that premiums for Tier 4 were greatest for Commercial Retail buildings at 16.9%. As noted in Section 3, costs per square foot for retail buildings tend to be the lowest among the primary archetypes in Toronto; as a result, increases in cost premiums have a relatively higher impact on overall cost. Retail construction is currently optimized to achieve the lowest first costs that are possible, which is facilitated by the current OBC. By changing the methodology to include a performance target for TEUI, retail buildings will be obliged to make more substantial investments in energy efficiency than other building types. The City of Toronto may therefore wish to consider additional incentives or support for retail buildings that wish to seek higher levels of performance.

---

<sup>4</sup> To encourage higher levels of performance, Tier 2 third party-certified projects are currently eligible for a significant refund of Development Charges (DC). The DC Refund incentive encourages efficient, green development that places a lower burden on infrastructure afforded by the City of Toronto. The "High Performance New Construction" program, funded by the Ontario Power Authority, also offers both design assistance and financial incentives for building design teams who exceed the energy efficiency requirements specified in the OBC. The program is administered by the City of Toronto.

<sup>5</sup> Note that the capital cost premiums included in this report do not account for the DC Refund, which would further decrease costs.

## LIFECYCLE COST ANALYSIS

In addition to developing a robust construction cost assessment for the present day, a long-term lifecycle cost analysis of the different sets of targets was conducted. The analysis calculation included a 25-year<sup>6</sup> levelized costing analysis that took into account the total cost for each of the scenarios, including the following:

- Construction costs;
- Electricity and natural gas costs (including cap and trade charges), based on blended consumption-based rates that escalate over time in line with Ontario's Long Term Energy Plan (see Table 11 below);
- Maintenance costs consistent with operations specifications of the mechanical equipment specified;
- A capital discount rate of 3%, consistent with federal government lifecycle cost analyses; and,
- The social cost of carbon used by Environment and Climate Change Canada.<sup>7</sup>

Table 11 Lifecycle cost energy rate assumptions

	Rate Category	2017 Blended Rate	Annual Rate Increase
<b>Electricity</b>	Residential	19.53 cents per kWh <sup>8</sup>	4%
	Commercial	19.41 cents per kWh	4%
<b>Natural gas</b>	Residential	\$8.04 per GJ <sup>9</sup>	2%
	Commercial	\$8.04 per GJ	2%

All of the above factors were entered into a model that allowed different options to be compared to a 'business as usual' (BAU) scenario, represented by SB-10 2017 requirements, over a period of 25 years (i.e. operations from 2018 to 2042). The purpose of this lifecycle cost analysis was to determine whether the new TGS targets would create a net-benefit to the owner over time, i.e. whether consumers would benefit from the higher energy requirements outlined in the new TGS. To complete this analysis, all costs associated with owning and operating the asset were modelled over a 25-year horizon, roughly aligned with the life span of the envelope and other major components. This included capital, maintenance, and energy costs.

Table 12 summarizes the key Tier 1 and 2 results for each archetype in the following tables, including percent changes in energy consumption and GHG emissions. As the table indicates, Tiers 1 and 2 result in net lifecycle savings when accounting for the development charge refund in most cases. Exceptions to this trend include Tier 1 of the Low-Rise MURB, which results in a minor \$0.03/ft<sup>2</sup> net lifecycle loss, as well as larger losses in Tiers 1 and 2 of Commercial Retail. As noted above, the low costs of retail per square foot result in relatively high premiums associated with capital costs at higher tiers, which likely contributes

<sup>6</sup> For energy rates, buildings are assumed to be constructed in 2017 and operated between 2018 and 2042. All values are presented in 2017CAD.

<sup>7</sup> From the March 2016 Technical Update to Environment and Climate Change Canada's Social Cost of Greenhouse Gas Estimates.

<sup>8</sup> Based on Toronto Hydro residential and business electricity rates.

<sup>9</sup> Based on Enbridge residential gas rates.

to these lifecycle cost results. Under the assumption that currently available technologies are used at current costs, buildings designed to meet Tier 3 typically resulted in higher lifecycle costs, with the exception of Commercial Office which yields a net savings. However, increasing levels of minimum performance in the OBC, coupled with anticipated cost reductions associated with technological advancements, will make the achievement of these tiers cost-effective over the longer term.

It is worth noting that in many cases, the most expensive scenario is represented by Tier 3, while moving to a Tier 4 level of performance is less costly to construct and will have lower lifecycle costs. This phenomenon has been referred to in energy efficiency literature as a process of “tunnelling through the cost barrier”, which is used to characterize those cases in which a more efficient building actually translates into lower construction costs. In nearly all cases, the construction cost savings in Tier 4 were attributed to the downsizing or elimination of mechanical equipment that was no longer needed. In both the High-Rise and Low-Rise MURB, this occurred due to improvements in envelope performance that greatly reduced the need to provide mechanical heating. In Commercial Office buildings, savings were attributed to using more economical envelope strategies, such as the selection of precast concrete over more costly curtain wall systems. While sometimes more desirable from a marketing perspective, curtain wall systems actually cost more than higher performing alternatives.

Table 12 Summary of lifecycle cost analysis results for Tiers 1 and 2

Archetype	Tier	% Construction Premium	Lifecycle Cost Savings*	% Change in GHG Emissions**	% Change in Electricity	% Change in Natural Gas
		Change vs. SB 10 2017				
<b>High-Rise MURB</b>	v3 T1	1.5%	\$0.12/ft <sup>2</sup>	-12%	-8%	-13%
	v3 T2	3.5%	\$1.15/ft <sup>2</sup>	-37%	-11%	-41%
<b>Low-Rise MURB</b>	v3 T1	0.5%	-\$0.03/ft <sup>2</sup>	-24%	+5%	-27%
	v3 T2	2.1%	\$1.97/ft <sup>2</sup>	-48%	+3%	-54%
<b>Commercial Office</b>	v3 T1	2.3%	\$0.62/ft <sup>2</sup>	-15%	-13%	-16%
	v3 T2	3.1%	\$3.58/ft <sup>2</sup>	-49%	-16%	-60%
<b>Commercial Retail</b>	v3 T1	0.7%	-\$3.87/ft <sup>2</sup>	-17%	+1%	-20%
	v3 T2	6.5%	-\$3.87/ft <sup>2</sup>	-54%	-10%	-63%

\*Negative values indicate a net increase in costs. Lifecycle cost results include the development charge refund for Tiers 2 through 4, but the construction premiums do not.

\*\*Electricity GHG emissions are based on the 2016 National Inventory Report and do not include future changes in electricity GHG intensity. Negative values indicate a reduction in emissions.



## 7. SUMMARY & NEXT STEPS

This report has provided a detailed overview to the proposed and recommended changes to the City of Toronto's current approach to building energy performance. The new Zero Emissions Buildings Framework comprises a pathway for the achievement of zero emissions buildings by 2030, a fully developed package of stepped performance targets for Toronto's primary building types, a set of administrative and prescriptive requirements to assist both building designers and in meeting their energy and emissions targets, and details on the implications of such changes to building cost and design. Besides the way it assists the City in meeting its climate and energy targets, there are several other key benefits of the new Framework. The construction of highly energy efficient buildings connected to local sources of energy and whose performance has been verified after construction provides the citizens of Toronto with safer, more comfortable homes and offices. The improved resilience and value of these higher performing buildings should be emphasized in all communications and outreach around the new Framework.

In total, the new Framework includes the following key components and recommendations:

- New absolute performance targets in TEUI, TEDI, and GHGI for five of Toronto's major building types;
- A pathway of stepped performance tiers to take the Toronto building industry from present day to a near zero emissions level of performance by 2030;
- Recommendations for the inclusion of prescriptive requirements for:
  - On-site renewable energy
  - District energy connection
  - Air tightness testing
  - Building commissioning
  - Submetering, and
  - Energy benchmarking and reporting;
- Energy modelling guidelines to ensure compliance, and
- A resilience checklist.

To facilitate the industry's transition towards this new absolute performance targets approach, the City of Toronto can offer a number of forms of support. These range from capacity building efforts, to appropriate incentives to reduce anticipated premiums. In this final section, some of these opportunities are described, with recommendations for further action where applicable.



## 7.1. IMPLEMENTATION & CAPACITY BUILDING

The City of Toronto is currently undertaking an assessment of new ways to improve the enforcement and implementation of the new ZEB Framework under the Toronto Green Standard. One means of allowing further flexibility in achieving the targets outlined in the Framework under consideration is to allow the use of the Passive House standard as an alternative compliance path mechanism. While this will provide some owners and developers the option to pursue a different approach to energy efficiency targets, the Passive House standard also demands higher levels of energy performance and a more rigorous process of third party verification, including the use of specific energy modelling software and the need for a certified Passive House consultant. As such, those who wish to seek Passive House certification should achieve higher-than-Tier 4 levels of performance, at higher cost but with the added recognition of a third party certification. Given this higher level of performance, the City may wish to consider offering an additional incentive package for offer to those who pursue this compliance pathway. Similarly, all four tiers of performance could be made available to the industry to pursue, but should be coupled with an appropriate level of incentive.

In addition, the City can offer its support in building industry capacity to understand and comply with the new ZEB Framework. Key areas of focus should include the following:

- **RAISING AWARENESS AND ABILITY.** Efforts should be made by the City of Toronto to connect with existing industry groups to help raise awareness of the new standard and connect design teams with the appropriate resources to help them achieve their targets. Several existing funding programs and institutions exist in Toronto that are seeking to raise levels of building performance. Pulling these efforts together and ensuring they are as aligned as possible will help industry capacity to grow.
- **AIR TIGHTNESS TESTING.** The design of incentive programs and pilot projects to help encourage the practice of air tightness testing and raise the capacity of the industry to perform it should be given priority. This includes connecting industry members to existing courses in air tightness testing, resources and FAQ, and specific guidelines for proper air tightness testing practice (e.g. US Army Corps of Engineers Air Leakage Proposal for Building Envelopes).
- **ENERGY MODELLING RESOURCES.** The City of Toronto should seek out partnerships with organizations (e.g. the International Building Performance Simulation Association, Sustainable Buildings Canada) to provide training courses and other resources to support the industry in the energy modelling required for compliance to the TGS. The energy modelling guidelines provided here are a first step, but opportunities to hold workshops and webinars on modelling requirements, including the calculation of thermal bridges, should be seized.

The City of Toronto should also be sure to continue monitoring the effectiveness of the program over time, using energy benchmarking data to compare actual building performance to modelled performance under different tiers to determine whether targets are being met. As noted above, recommended requirements for air tightness testing may be raised over time – for example, if air tightness testing results are showing poor overall envelope performance, the City may wish to increase the requirement from the performance of an air tightness test, to specific levels of airtightness, as in the City of Seattle. Monitoring performance over time may also point to specific training needs over time.





## 7.2. INCENTIVIZING PERFORMANCE

The City of Toronto offers a significant Development Charge (DC) Refund to third party certified Tier 2 developments. The incentive covers a substantial portion of the premium for energy efficiency measures in construction. However, the new targets and additional performance tiers that make up the Zero Emissions Buildings Framework warrant an investigation into additional means of supporting those that pursue the higher Tiers 3 and 4. At present, the support that the DC Refund provides to different building types and tiers varies considerably, depending on the development charges paid. For example, some forms of development have reduced Development Charges or are exempt from charges altogether as another form of incentive. High-Rise MURB developments that pay the largest Development Charges benefit the most from the refund, whereas non-residential and commercial buildings that only pay Development Charges for the first above-grade storey receive less of a financial incentive from the Refund.

To help encourage the early adoption of higher performing tiers (i.e. Tiers 3 and 4), the City of Toronto may wish to revise its current DC Refund offering to make increasing levels of incentive or support for higher tiers of performance. Other forms of incentivization to support those developments that have committed to higher tiers early on and/or assist in fast tracking Tier 3 and Tier 4 compliant buildings should also be explored. One innovative approach to incentivizing high performance buildings that is emerging is the “feebate” system (fee + rebate), in which charges are levied on lower or under-performing buildings, which are in turn refunded to higher performing building on a sliding scale.<sup>xix</sup> Such programs are structured by first setting a certain performance threshold, followed by accompanying tiers to indicate different levels of performance either above or below the threshold to which specific charges or rebates are allocated or waived. The feebate system creates a self-sustaining and revenue-neutral source of support for high building performance. Feebates are being considered for the automotive industry to improve fuel efficiency as well as for building performance improvements.

Another option is to finance the cost of energy efficiency improvements via low-interest loan program, similar to the [Green Condo Loan](#) formerly offered by the Toronto Atmospheric Fund. The loan offered an incentive to cover the incremental cost of energy efficiency measures to meet a minimum of 25% better than OBC level of performance. The loan was provided at market interest rates to the developer once the development was signed over to the condominium corporation, and paid back by the condominium corporation, to ensure that both the costs and the benefits of resultant operational energy savings were borne by building owners and managers.

A similar approach has been taken by large equipment manufacturers and service providers (e.g. Corix, Johnson Controls) and utilities (e.g. FortisBC) to finance energy efficient products. When considering a similar approach, the City of Toronto may wish to explore offering lower than market interest rates as a way of encouraging higher uptake.

In addition to these more innovative approaches, several other sources of incentives for high performance buildings already exist, and should be promoted to and by the industry. Some of these include:

- [Savings By Design](#): A green building initiative offered by Enbridge Gas Distribution. The program offers support for green building design and construction practices via access to sustainable building expertise, and up to \$30,000 in financial incentives for buildings that achieve a 25% reduction in energy use over OBC 2012 with SB-10.
- [High Performance New Construction](#): Commercial, institutional and MURB projects in Ontario that exceed minimum energy performance requirements of the OBC are eligible for packages of incentives according to specific types of energy saving measures. The program provides important financial support for energy modelling which will be important for helping to implement the new Energy Modelling Guidelines. The program is offered by the Independent Electricity System Operator and administered via hydro companies through the Save on Energy program.
- [CMHC Green Home](#): The Canadian Mortgage and Housing Corporation offers premium refunds to homeowners who purchase condominium units that have been designed to exceed the energy efficiency of OBC-compliant buildings. A 15% premium refund is offered for units that exceed the OBC by 20%, and a 25% refund to buildings that exceed the OBC by 40%.
- [IMIT](#): The Imagination, Manufacturing, Innovation, Technology Incentive program offered by the City of Toronto supports new building projects in select sectors (e.g. creative industries, manufacturing, tourism) by offering a grant of 60% of the increase in the municipal taxes over a 10-year period. A Tier 1 level of building performance is one of several eligibility requirements and could be amended to higher tiers of performance.

These additional sources of incentives should be highlighted as means of funding any cost premiums associated with the early adoption of higher tiers (e.g. Tier 3, Tier 4). Early adoption has the dual benefit of improving the City's energy and emissions performance overall, and providing valuable demonstrations to the industry of how targets can be met. In the future, additional funding via the institution of the Provincial carbon tax may become available as well.

# GLOSSARY

<b>ASHP</b>	Air Source Heat Pump
<b>AS VRF</b>	Air Source Variable Refrigerant Flow
<b>DHW</b>	Domestic Hot Water
<b>DOAS</b>	Dedicated Outdoor Air System
<b>ECM</b>	Electronically Commutated Motor
<b>EUI</b>	Energy Use Intensity
<b>ERV</b>	Energy Recovery Ventilation
<b>GHG</b>	Greenhouse Gas
<b>GHGI</b>	Greenhouse Gas Intensity
<b>H/C</b>	Heating/Cooling
<b>HRV</b>	Heat Recovery Ventilator
<b>HVAC</b>	Heating, Ventilation, Air Conditioning
<b>LPD</b>	Lighting Power Density
<b>MUA</b>	Make-Up Air
<b>MURB</b>	Multi-Unit Residential Building
<b>NECB</b>	National Energy Code for Buildings
<b>PH</b>	Passive House
<b>PPD</b>	Primary Power Distribution
<b>TEDI</b>	Thermal Energy Demand Intensity
<b>TEUI</b>	Total Energy Use Intensity
<b>VFD</b>	Variable Frequency Drive

# APPENDIX A: PERFORMANCE TARGETS – ALL BUILDINGS

Building Archetype	Scenario	Proposed Annual Targets*		
		EUI (kWh/m <sup>2</sup> )	TEDI (kWh/m <sup>2</sup> )	GHG (kg/m <sup>2</sup> )
<b>High Rise MURB</b> 30 Storeys, 243,890 ft <sup>2</sup> , 4 pipe H/C system with central plant, MUA ventilation for corridors, HRV/ERV for suites	<b>TGS v2 T1 (SB-10 2017)</b>	190	77	26
	<b>TGS v2 T2</b>	170	70	20
	<b>TGS v3 T1</b>	170	70	20
	<b>TGS v3 T2</b>	135	50	15
	<b>TGS v3 T3</b>	100	30	10
	<b>TGS v3 T4</b>	75	15	5
<b>4-6 Storey Wood Frame MURB</b> 56,910 ft <sup>2</sup> , 4 Stories, 4 pipe H/C system with central plant, MUA ventilation for corridors, HRV/ERV for suites	<b>TGS v2 T1 (SB-10 2017)</b>	198	97	28
	<b>TGS v2 T2</b>	165	65	20
	<b>TGS v3 T1</b>	165	65	20
	<b>TGS v3 T2</b>	130	40	15
	<b>TGS v3 T3</b>	100	25	10
	<b>TGS v3 T4</b>	70	15	5
<b>Office Building</b> 10 Stories, 196,000 ft <sup>2</sup> , HVAC system is typical VAV with reheat or 100% DOAS with Terminal h/c	<b>TGS v2 T1 (SB-10 2017)</b>	200	82	23
	<b>TGS v2 T2</b>	175	70	20
	<b>TGS v3 T1</b>	175	70	20
	<b>TGS v3 T2</b>	130	30	15
	<b>TGS v3 T3</b>	100	22	8
	<b>TGS v3 T4</b>	65	15	4
<b>Retail Building</b> Single story, 48,460 ft <sup>2</sup> (big box example), HVAC is Rooftop units or HRV/ERV with terminal h/c	<b>TGS v2 T1 (SB-10 2017)</b>	190	75	24
	<b>TGS v2 T2</b>	170	60	20
	<b>TGS v3 T1</b>	170	60	20
	<b>TGS v3 T2</b>	120	40	10
	<b>TGS v3 T3</b>	90	25	5
	<b>TGS v3 T4</b>	70	15	3
<b>Mixed Use: 90% Residential, 5% Retail, 5% Commercial</b>	<b>TGS v2 T1 (SB-10 2017)</b>	191	77	26
	<b>TGS v2 T2</b>	170	70	20
	<b>TGS v3 T1</b>	170	70	20
	<b>TGS v3 T2</b>	134	49	15
	<b>TGS v3 T3</b>	100	29	10
	<b>TGS v3 T4</b>	74	15	5

SB-10 (2017) was used as the baseline for all targets. GHGI targets were calculated using CO<sub>2</sub>e emissions factors from SB-10 (Table 1.1.2.2). While modelled characteristics associated with each target are based in one sample set of criteria, there are several design options that can be used. Small variations in R-values and U-values are expected. The overall intent of results is to set achievable targets, not specify design solutions. Proposed targets are not always direct outputs of models; some have been increased slightly above modeled outputs to provide a more general progression towards near net zero.

# APPENDIX B – ARCHETYPE DESCRIPTIONS & MODELLING INPUT SUMMARIES

## HIGH-RISE MURB

**Floor Area:** 243,890 ft<sup>2</sup> (22,660 m<sup>2</sup>)

**Parking Floor Area:** 113,750 ft<sup>2</sup> (10,570 m<sup>2</sup>), ~360 spaces

**Floors:** 30 x 9ft (2.74m)

**Wall-to-Floor Area Ratio:** 0.4

### Schedules:

- NECB G Schedules for occupancy, lighting and plug loads
- Corridor and Parking lighting 24/7
- Parking Ventilation 4h/day, 0.5W/cfm fans

**Occupants:** 722 people, 301 suites

**DHW Load:** 500 W/person

**In-Suite OA:** 20,770 cfm (9.8 m<sup>3</sup>/s)

### Corridor OA:

- 0.3 L/s/m<sup>2</sup>: 1,500 cfm (0.7 m<sup>3</sup>/s)
- 15 cfm/suite: 4,520 cfm (2.13 m<sup>3</sup>/s)
- 30 cfm/suite: 9,030 cfm (4.26 m<sup>3</sup>/s)

### NECB 2015 Baseline Lighting:

5 W/m<sup>2</sup> Units, 7.1 W/m<sup>2</sup> Corridors, 7.8 W/m<sup>2</sup> Fitness, Pool, 2W/m<sup>2</sup> parking

### HVAC Systems:

- Constant Volume Corridor MUA, without Heat Recovery, 1 or 0.5 W/cfm
- Constant Volume Suite Ventilators, with Heat Recovery, 1 or 0.5 W/cfm
- Cycling or Constant Suite Fan Coils, 0.5 or 0.3 W/cfm
- High Efficiency Plant
  - Condensing Boiler with 96% seasonal efficiency
  - Screw Chiller with 5 seasonal COP
- Air-source Heat Pump Plant
  - Cooling 3.15 nominal COP
  - Heating 4.15 nominal COP
  - Backup condensing or electric boiler for heating plant and DHW top up

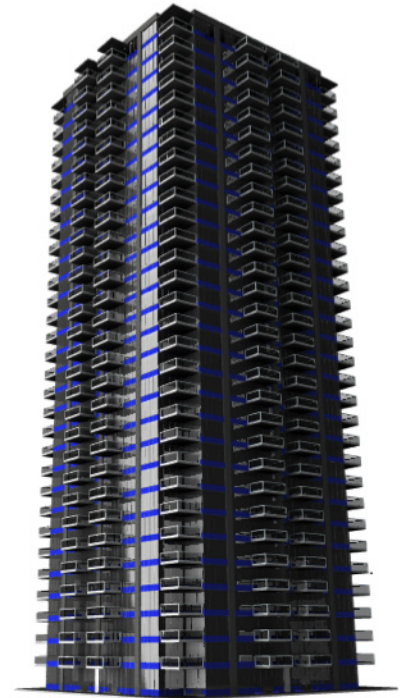

Characteristic	High Rise MURB
Weather	Toronto CWEC
Software	EnergyPlus v8.6
Climate Zone	5A
Building Area	22,658 m <sup>2</sup> plus 10,568 m <sup>2</sup> parking
Operating Hours	NECB Schedule G occupancy, lighting and plug loads for suites. NECB Schedule B occupancy, lighting and plug loads for fitness. Corridor and parking lighting always on.
Occupancy	100 m <sup>2</sup> /person Corridor 27.9 m <sup>2</sup> /person Suites 5 m <sup>2</sup> /person Fitness, Pool
Plug & Process Loads	5 W/m <sup>2</sup> Suites 1 W/m <sup>2</sup> Fitness, Pool  4.5 kW elevator load 30 kW Suite exhaust fans, 2 h/day 41.4 kW Parking exhaust fans, 4 h/day Pool water heating, pumping and latent loads  Options: Up to 20% reduction in suite, fitness, and pool plug loads
Outdoor Air	Per ASHRAE 62.1-2010 Suites: 2.5 L/s/person and 0.3 L/s/m <sup>2</sup> Ventilation effectiveness 0.8 for boiler options, and 1 for heat pump options Corridors: 30 cfm/suites Pool: 2.4 L/s/m <sup>2</sup> Fitness: 10 L/s/person and 0.3 L/s/m <sup>2</sup>  Options: Corridor ventilation rate reduction, 30 cfm/suite to 0.3 L/s/m <sup>2</sup>
Infiltration	0.25 L/s/m <sup>2</sup> Exterior Area, Code DOE-2 Coefficients Options: Up to 75% reduction
Wall R-Value	Options: R-3 to R-20
Roof R-Value	R-20
Window U-Value	Options: U-0.4 to U-0.14
Window SHGC	0.35
Window Area %	Options: 60% to 40%
Lighting	5 W/m <sup>2</sup> Suites 7.1 W/m <sup>2</sup> Corridors 7.8 W/m <sup>2</sup> Fitness, Pool 2 W/m <sup>2</sup> Parking  Options: Up to 50% reduction in common area lighting
HVAC Systems	Suites: Hydronic Fan Coils and ERVs Corridors: MUA with Hydronic baseboards Fitness and Pool: Unitary Systems, pool with cool/reheat humidity control

<b>Supply and Ventilation Air</b>	Constant ventilation air supplied directly to zones through DOAS. Fan coil fans cycle to meet heating and cooling loads.
<b>Heat Recovery</b>	Options: 65% to 85% Suite ERV efficiency, Electric Preheat Coil to -5°C
<b>Fans</b>	Options: Standard: 1.0 W/cfm ERVs, Corridor MUA 1.2 W/cfm Fitness, Pool Unitary 0.5 W/cfm Fan Coils, continuous  ECM: 0.5 W/cfm ERVs, Corridor MUA 0.75 W/cfm Fitness, Pool Unitary 0.3 W/cfm Fan Coils, cycling
<b>Cooling</b>	Options Boiler Plant: Water-cooled Screw Chiller, COP 5.2 ASHP Plant: ASHP, COP 3.15
<b>Heating</b>	Options Boiler Plant: Mid-Efficiency Boiler, 85% eff. or Condensing Boiler, 97% eff. ASHP Plant: ASHP, COP 4.15, condensing or electric boiler top-up
<b>Pumps</b>	72 ft. head, variable speed HW, DHW, ChW Secondary, and CndW 72 ft. head, constant speed ChW Primary
<b>DHW</b>	500 W/person Suites Same as Heating Plant, with top up boiler for supply temperature Options: Up to 50% load savings

## LOW-RISE MURB

**Floor Area:** 56,910 ft<sup>2</sup> (5,290 m<sup>2</sup>)

**Parking Floor Area:** 25,320 ft<sup>2</sup> (2,350 m<sup>2</sup>), 80 spaces

**Floors:** 4 x 9ft (2.74m)

**Wall-to-Floor Area Ratio:** 0.6

### Schedules:

- NECB G Schedules for occupancy, lighting and plug loads
- Corridor and Parking lighting 24/7
- Parking Ventilation 4h/day, 0.5W/cfm fans
- Suite Exhaust, 150 cfm/suite, 2h/day, 0.5W/cfm fans

**Occupants:** 160 people, 67 suites

**DHW Load:** 500 W/person

**In-Suite OA:** 4,650 cfm (2.20 m<sup>3</sup>/s)

**Corridor OA:** 0.3 L/s/m<sup>2</sup>, 490 cfm (0.23 m<sup>3</sup>/s)

### NECB 2015 Baseline Lighting:

5 W/m<sup>2</sup> Units, 7.1 W/m<sup>2</sup> Corridors, 7.8 W/m<sup>2</sup> Fitness, 2W/m<sup>2</sup> parking

### HVAC Systems:

- Constant Volume Corridor MUA, without Heat Recovery, 1 or 0.5 W/cfm
- Constant Volume Suite Ventilators, with Heat Recovery, 1 or 0.5 W/cfm
- Cycling or Constant Suite Fan Coils, 0.5 or 0.2 W/cfm
- Mid Efficiency Plant
  - Mid-efficiency Boiler with 85% seasonal efficiency
  - Screw Chiller with 5 seasonal COP
- High Efficiency Plant
  - Condensing Boiler with 96% seasonal efficiency
  - Screw Chiller with 5 seasonal COP
- Air-source Heat Pump Plant
  - Cooling 3.15 nominal COP
  - Heating 4.15 nominal COP
  - Backup condensing or electric boiler for heating plant and DHW top up





Characteristic	Low Rise MURB
Weather	Toronto CWEC
Software	EnergyPlus v8.6
Climate Zone	5A
Building Area	5,366 m <sup>2</sup> plus 2,352 m <sup>2</sup> parking
Operating Hours	NECB Schedule G occupancy, lighting and plug loads for suites. NECB Schedule B occupancy, lighting and plug loads for fitness. Corridor and parking lighting always on.
Occupancy	100 m <sup>2</sup> /person Corridor 27.9 m <sup>2</sup> /person Suites 5 m <sup>2</sup> /person Fitness
Plug & Process Loads	5 W/m <sup>2</sup> Suites 1 W/m <sup>2</sup> Fitness  1.0 kW elevator load 4 kW Suite exhaust fans, 2 h/day 9.2 kW Parking exhaust fans, 4 h/day  Options: Up to 20% reduction in suite, fitness plug loads
Outdoor Air	Per ASHRAE 62.1-2010 Suites: 2.5 L/s/person and 0.3 L/s/m <sup>2</sup> Ventilation effectiveness 0.8 for boiler options, and 1 for heat pump options Corridors: 0.3 L/s/m <sup>2</sup> Pool: 2.4 L/s/m <sup>2</sup> Fitness: 10 L/s/person and 0.3 L/s/m <sup>2</sup>
Infiltration	0.25 L/s/m <sup>2</sup> Exterior Area, Code DOE-2 Coefficients Options: Up to 75% reduction
Wall R-Value	Options: R-10 to R-30
Roof R-Value	Options: R-20 to R-40
Window U-Value	Options: U-0.4 to U-0.14
Window SHGC	0.35
Window Area %	Options: 40% to 30%
Lighting	5 W/m <sup>2</sup> Suites 7.1 W/m <sup>2</sup> Corridors 7.8 W/m <sup>2</sup> Fitness 2 W/m <sup>2</sup> Parking 2 kW Exterior Lights Options: Up to 50% reduction in common area lighting
HVAC Systems	Suites: Hydronic Fan Coils and ERVs Corridors: MUA with Hydronic baseboards Fitness: Hydronic Unitary System
Supply and Ventilation Air	Constant ventilation air supplied directly to zones through DOAS. Fan coil fans cycle to meet heating and cooling loads.
Heat Recovery	Options: None to 85% Suite ERV efficiency, Electric Preheat Coil to -5°C

<b>Fans</b>	<p>Options: Standard: 1.0 W/cfm ERVs, Corridor MUA 1.2 W/cfm Fitness, Pool Unitary 0.5 W/cfm Fan Coils, continuous or cycling</p> <p>ECM: 0.5 W/cfm ERVs, Corridor MUA 0.75 W/cfm Fitness, Pool Unitary 0.2 W/cfm Fan Coils, cycling</p>
<b>Cooling</b>	<p>Options Boiler Plant: Water-cooled Screw Chiller, COP 5.2 ASHP Plant: ASHP, COP 3.15</p>
<b>Heating</b>	<p>Options Boiler Plant: Mid-Efficiency Boiler, 85% eff. or Condensing Boiler, 97% eff. ASHP Plant: ASHP, COP 4.15, condensing or electric boiler top-up</p>
<b>Pumps</b>	<p>72 ft. head, variable speed HW, DHW, ChW Secondary, and CndW 72 ft. head, constant speed ChW Primary</p>
<b>DHW</b>	<p>500 W/person Suites Same as Heating Plant, with top up boiler for supply temperature Options: Up to 50% load savings</p>

## COMMERCIAL OFFICE

**Floor Area:** 196,000 ft<sup>2</sup> (18,200 m<sup>2</sup>)

**Parking Floor Area:** 93,650 ft<sup>2</sup> (8,700 m<sup>2</sup>), ~220 spaces

**Floors:** 10 x 12ft (3.66m)

### Schedules:

- NECB A Schedules for occupancy, lighting and plug loads
- IT Load and Parking lighting, 24/7
- Parking Ventilation 4h/day, heated to 5°C, 0.5W/cfm fans

**DHW Load:** 90 W/per Office, 45 W/per Conference

### Internal Load Cases, area weighted average of typical space types:

- 790 people
- 4.42 W/m<sup>2</sup> plug load
- 10,800 W IT Load
- 10.85 W/m<sup>2</sup> baseline lighting load
- VAV OA, 45,000 cfm (21.2 m<sup>3</sup>/s), accounting for system efficiency
- DOAS OA, 31,500 cfm (14.9 m<sup>3</sup>/s)

### Secondary Systems:

- Fan Coils and Dedicated Outdoor Air System (FC/DOAS)
  - DOAS, with Heat Recovery, 1 W/cfm
  - Cycling Zone Fan Coils, 0.3 W/cfm
- VAV System
  - Without Heat Recovery, 0.67 W/cfm

### Boiler/Chiller Plant:

- Standard Plant
  - Mid-efficiency Boiler with 85% seasonal efficiency
  - Centrifugal Chiller with 4 seasonal COP
- High Efficiency Plant
  - Condensing Boiler with 96% seasonal efficiency
  - Mag-bearing Chiller with 8 seasonal COP
- Air-source Heat Pump Plant
  - Cooling 3.15 nominal COP
  - Heating 4.15 nominal COP
  - With backup condensing boiler for heating plant and DHW top up

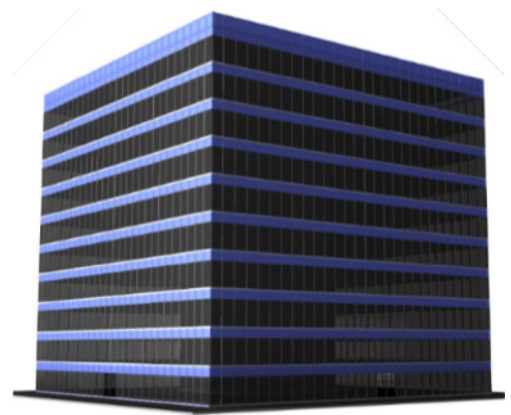

Characteristic	Office
Weather	Toronto CWEC
Software	EnergyPlus v8.6
Climate Zone	5A
Building Area	18,209 m <sup>2</sup> plus 8,700 m <sup>2</sup> parking
Operating Hours	NECB Schedule A occupancy, lighting and plug loads. Parking lighting always on.
Occupancy	20 m <sup>2</sup> /person Office 10 m <sup>2</sup> /person Lobby 3.33 m <sup>2</sup> /person Reception 2 m <sup>2</sup> /person Conference
Plug & Process Loads	7.5 W/m <sup>2</sup> Office 1 W/m <sup>2</sup> Conference, Reception, Lobby, Storage  3.5 kW elevator load 10.8 kW IT load 12 kW general exhaust fans, 2 h/day 34.1 kW Parking exhaust fans, 4 h/day  Options: Up to 25% reduction in plug loads
Outdoor Air	Per ASHRAE 62.1-2010 2.5 L/s/person and 0.3 to 0.6 L/s/m <sup>2</sup> Ventilation Effectiveness 0.8 for boiler options, and 1 for heat pump options System Ventilation Effectiveness 0.7 to 0.85 for VAV systems, 1 for DOAS systems
Infiltration	0.25 L/s/m <sup>2</sup> Exterior Area, Code DOE-2 Coefficients Options: Up to 75% reduction
Wall R-Value	Options: R-5 to R-20
Roof R-Value	Options: R-20 to R-30
Window U-Value	Options: U-0.4 to U-0.14
Window SHGC	0.4
Window Area %	Options: 60% to 40%
Lighting	11.9 W/m <sup>2</sup> Office 13.2 W/m <sup>2</sup> Conference 7.1 W/m <sup>2</sup> Corridors 7.9 W/m <sup>2</sup> Reception 9.7 W/m <sup>2</sup> Lobby 6.8 W/m <sup>2</sup> Storage 2 W/m <sup>2</sup> Parking 4 kW Exterior Lights Options: Up to 50% reduction in lighting
HVAC Systems	Options: Hydronic VAV Hydronic Fan Coils and DOAS
Supply and Ventilation Air	Ventilation air supplied directly to zones through DOAS or VAV system. Fan coil fans cycle to meet heating and cooling loads.
Heat Recovery	Options: Up to 90% Heat Recovery efficiency, Electric Preheat Coil to -5°C

<b>Fans</b>	<p>VAV Fans: 0.67 W/cfm, ASHRAE 90.1 Variable Fan Curve, or VFD Curve</p> <p>DOAS: 1 W/cfm Fan Coils: 0.3 W/cfm</p>
<b>Cooling</b>	<p>Options Boiler Plant: Water-cooled Centrifugal Chiller, COP 5.2 Or Water-cooled Mag-Bearing Chiller, COP 8</p> <p>ASHP Plant: ASHP, COP 3.15</p>
<b>Heating</b>	<p>Options Boiler Plant: Mid-Efficiency Boiler, 85% eff. or Condensing Boiler, 97% eff.</p> <p>ASHP Plant: ASHP, COP 4.15, condensing boiler top-up</p>
<b>Pumps</b>	<p>72 ft. head, variable speed HW, DHW, ChW Secondary, and CndW 72 ft. head, constant speed ChW Primary</p>
<b>DHW</b>	<p>90 W/person Office 45 W/person Conference Same as Heating Plant, with top up boiler for supply temperature Options: Up to 25% load savings</p>

## COMMERCIAL RETAIL

**Floor Area:** 48,460 ft<sup>2</sup> (4,500 m<sup>2</sup>)

**Floors:** 1 x 20 ft (6.1 m)

### Schedules:

- NECB C Schedules for occupancy, lighting and plug loads

**Occupants:** 150 people

**DHW Load:** 40 W/person

**OA:** 8,630 cfm (4.07 m<sup>3</sup>/s)

**NECB 2015 Baseline Lighting:** 13.5 W/m<sup>2</sup>

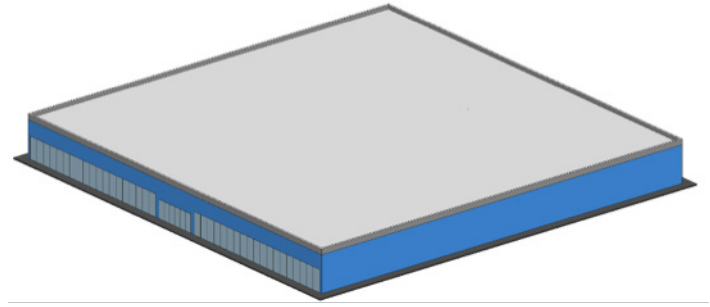

### Configuration:

- Big Box stores include heat loss at four walls and roof, glazing on all sides to average orientation effects

### HVAC Systems:

- Fan Coils and Dedicated Outdoor Air System (FC/DOAS)
  - DOAS, with Heat Recovery, 1 W/cfm
  - Cycling Zone Fan Coils, 0.5 W/cfm
- High Efficiency Plant
  - Condensing Boiler with 96% seasonal efficiency
  - Centrifugal Chiller with 4 seasonal COP
- Air-source Heat Pump Plant
  - Cooling 3.15 nominal COP
  - Heating 4.15 nominal COP
  - Backup condensing or electric boiler for heating plant and DHW top up
- Unitary Roof-top Systems
  - Gas-fired heating with DX Coil, 1 W/cfm, with and without Heat Recovery

Characteristic	Retail
Weather	Toronto CWEC
Software	EnergyPlus v8.6
Climate Zone	5A
Building Area	4,502 m <sup>2</sup>
Operating Hours	NECB Schedule C occupancy, lighting and plug loads.
Occupancy	30 m <sup>2</sup> /person
Plug & Process Loads	2.5 W/m <sup>2</sup>
Outdoor Air	Per ASHRAE 62.1-2010 3.7 L/s/person and 0.6 L/s/m <sup>2</sup> Ventilation Effectiveness 0.8 for unitary and boiler options, and 1 for heat pump options
Infiltration	0.25 L/s/m <sup>2</sup> Exterior Area, Code DOE-2 Coefficients Options: Up to 75% reduction
Wall R-Value	Options: R-10 to R-30
Roof R-Value	Options: R-20 to R-40
Window U-Value	Options: U-0.4 to U-0.14
Window SHGC	0.35
Window Area %	20%
Lighting	13.5 W/m <sup>2</sup> Options: Up to 50% reduction in lighting
HVAC Systems	Options: Unitary Gas Roof-top Units Hydronic Fan Coils and DOAS
Supply and Ventilation Air	Ventilation air supplied directly to zones through DOAS or Unitary system. Fan coil fans cycle to meet heating and cooling loads.
Heat Recovery	Options: Up to 90% Heat Recovery efficiency, Electric Preheat Coil to -5°C
Fans	Unitary: 1 W/cfm DOAS: 1 W/cfm Fan Coils: 0.5 W/cfm
Cooling	Options Unitary: DX Cooling, COP 3.8 Boiler: Water-cooled Centrifugal Chiller, COP 5.2 ASHP Plant: ASHP, COP 3.15
Heating	Options Unitary: Gas Coil, 70% eff. Boiler Plant: Mid-Efficiency Boiler, 85% eff. or Condensing Boiler, 97% eff. ASHP Plant: ASHP, COP 4.15, condensing or electric boiler top-up
Pumps	72 ft. head, variable speed HW, DHW, ChW Secondary, and CndW 72 ft. head, constant speed ChW Primary
DHW	40 W/person Same as Heating Plant, with top up boiler for supply temperature

# APPENDIX C – PARAMETRIC MODELLING RESULTS

## HIGH-RISE MURB

High Rise	TGS v2 T1 (SB 10 2017)	TGS v2 T2	TGS v3 T1	TGS v3 T2	TGS v3 T3	TGS v3 T4
WWR (%)	50	40		40	40	40
Wall R-Value	7	10		10	10	20
Roof R-Value	20	20		20	20	20
Win U-Value	0.4	0.4		0.3	0.2	0.14
Infil. Savings (%)	Code	Code		25	50	75
Lighting Savings (%)	0	30 com.		30 com.	50 com.	50 com.
Plug Savings (%)	0	0		10	10	20
Fans	ECM	ECM		ECM	ECM	ECM
Heat Recovery (%)	65 units	65 units		75 units	80 units	85 units
Vent. Effectiveness	0.8	0.8		0.8	1	1
Corridor Ventilation	30 cfm/ste	30 cfm/ste		15 cfm/ste	15 cfm/ste	0.3 L/s/m <sup>2</sup>
Plant	C Boiler/ Screw	C Boiler/ Screw		C Boiler/ Screw	50% ASHP, gas top up	90% ASHP, elec top up
DHW Savings	0	20		30	40	50
EUI (kWh/m <sup>2</sup> )	190.2	169.5		133.0	99.8	74.4
TEDI (kWh/m <sup>2</sup> )	76.8	70.6		42.2	29.0	9.4
GHG (kg/m <sup>2</sup> )	25.7	22.6		16.2	9.0	3.7
Targets						
EUI (kWh/m <sup>2</sup> )	<b>190</b>	<b>170</b>	<b>170</b>	<b>135</b>	<b>100</b>	<b>75</b>
TEDI (kWh/m <sup>2</sup> )	<b>77</b>	<b>70</b>	<b>70</b>	<b>50</b>	<b>30</b>	<b>15</b>
GHG (kg/m <sup>2</sup> )	<b>26</b>	<b>20</b>	<b>20</b>	<b>15</b>	<b>10</b>	<b>5</b>
Energy Savings over SB-10	-	<b>11%</b>	<b>11%</b>	<b>29%</b>	<b>47%</b>	<b>61%</b>
Winter	15.0	14.3		13.7	15.5	21.5
Summer	19.7	18.5		17.2	21.0	20.5
Total Gas	121.5	106.2		72.1	30.3	0.0
Total Electricity	68.8	63.3		60.9	69.4	74.4
Heating Gas	77.0	70.6		41.0	25.5	0.0
Heating Elec	2.9	2.9		2.9	2.9	5.5
DHW Gas	44.5	35.6		31.1	4.9	0.0
DHW Elec	0.0	0.0		0.0	3.3	5.7
Cooling	5.2	4.9		5.4	12.0	14.0
Lights	24.0	19.5		19.5	16.6	16.6
Plug	22.6	22.6		20.9	20.9	19.2
Fans	7.8	7.6		6.6	6.0	5.7
Pumps	4.8	4.5		4.2	7.8	7.8
Heat Rejection	1.5	1.4		1.3	0.0	0.0



LOW-RISE MURB

Low Rise	TGS v2 T1 (SB-10 2017)	TGS v2 T2	TGS v3 T1	TGS v3 T2	TGS v3 T3	TGS v3 T4
WWR (%)	40	40		30	30	30
Wall R-Value	10	20		20	30	30
Roof R-Value	20	20		30	40	40
Win U-Value	0.3	0.3		0.2	0.2	0.14
Infil. Savings (%)	Code	Code		25	50	75
Lighting Savings (%)	30 com.	30 com.		30 com.	50 com.	50 com.
Plug Savings (%)	0	0		10	10	20
Fans	Stan., cycl.	Stan., cycl.		Stan., cycl.	ECM	ECM
Heat Recovery (%)	None	50 units		75 units	80 units	85 units
Vent. Effectiveness	0.8	0.8		0.8	1	1
Corridor Ventilation	0.3 L/s/m <sup>2</sup>	0.3 L/s/m <sup>2</sup>		0.3 L/s/m <sup>2</sup>	0.3 L/s/m <sup>2</sup>	0.3 L/s/m <sup>2</sup>
Plant	C Boiler/ Screw	C Boiler/ Screw		C Boiler/ Screw	25% ASHP, gas top up	ASHP, elec top up
DHW Savings	20	20		30	40	50
EUI (kWh/m <sup>2</sup> )	198.0	164.2		127.3	96.3	66.6
TEDI (kWh/m <sup>2</sup> )	96.7	64.7		34.4	24.9	15.3
GHG (kg/m <sup>2</sup> )	27.8	21.2		14.5	10.0	3.3
Targets						
EUI (kWh/m <sup>2</sup> )	<b>198</b>	<b>165</b>	<b>165</b>	<b>130</b>	<b>100</b>	<b>70</b>
TEDI (kWh/m <sup>2</sup> )	<b>97</b>	<b>65</b>	<b>65</b>	<b>40</b>	<b>25</b>	<b>15</b>
GHG (kg/m <sup>2</sup> )	<b>28</b>	<b>20</b>	<b>20</b>	<b>15</b>	<b>10</b>	<b>5</b>
Energy Savings over SB-10	-	<b>17%</b>	<b>17%</b>	<b>34%</b>	<b>49%</b>	<b>65%</b>
Winter	13.6	14.4		14.6	13.5	14.2
Summer	19.6	19.3		18.1	18.0	17.8
Total Gas	134.4	97.5		61.4	39.1	0.0
Total Electricity	63.7	66.7		65.9	57.2	66.6
Heating Gas	101.6	64.7		32.7	34.6	0.0
Heating Elec	0.0	2.7		2.7	0.4	11.2
DHW Gas	32.8	32.8		28.7	4.5	0.0
DHW Elec	0.0	0.0		0.0	2.9	0.0
Cooling	3.8	4.7		5.6	8.0	11.0
Lights	21.5	21.5		21.5	17.8	17.8
Plug	20.8	20.8		19.1	19.1	17.5
Fans	13.8	13.0		12.6	5.4	5.4
Pumps	2.8	3.0		3.2	3.7	3.7
Heat Rejection	1.0	1.2		1.2	0.0	0.0

COMMERCIAL OFFICE

Office	TGS v2 T1 (SB 10 2017)	TGS v2 T2	TGS v3 T1	TGS v3 T2	TGS v3 T3	TGS v3 T4
WWR (%)	50	40		40	40	40
Wall R-Value	7	10		10	10	20
Roof R-Value	20	20		20	20	30
Win U-Value	0.4	0.4		0.3	0.2	0.14
Infil. Savings (%)	Code	Code		25	50	75
Lighting Savings (%)	0	25		25	50	70
Plug Savings (%)	0	0		0	25	25
Fans	VFD	VFD		ECM	ECM	ECM
Heat Recovery (%)	None	None		60	90	90
Vent. Effectiveness	0.56	0.68		0.8	1	1
HVAC	VAV	VAV		DOAS FC	DOAS FC	DOAS FC
Plant	C Boiler/ Cent	C Boiler/ Mag		C Boiler/ Mag	C Boiler/ Mag	90% ASHP, gas top up
DHW Savings	25	25		25	25	25
EUI (kWh/m <sup>2</sup> )	199.6	171.1		126.7	99.8	64.6
TEDI (kWh/m <sup>2</sup> )	82.4	67.8		29.3	17.1	8.1
GHG (kg/m <sup>2</sup> )	22.6	19.1		11.4	8.6	3.7
Targets						
EUI (kWh/m <sup>2</sup> )	<b>200</b>	<b>175</b>	<b>175</b>	<b>130</b>	<b>100</b>	<b>65</b>
TEDI (kWh/m <sup>2</sup> )	<b>82</b>	<b>70</b>	<b>70</b>	<b>30</b>	<b>22</b>	<b>15</b>
GHG (kg/m <sup>2</sup> )	<b>23</b>	<b>20</b>	<b>20</b>	<b>15</b>	<b>8</b>	<b>4</b>
Energy Savings over SB-10	-	<b>13%</b>	<b>13%</b>	<b>35%</b>	<b>50%</b>	<b>68%</b>
Winter	23.2	19.9		21.0	17.0	16.2
Summer	32.3	26.0		25.7	20.5	22.5
Total Gas	94.8	79.4		38.3	27.1	3.8
Total Electricity	104.9	91.7		88.4	72.7	60.8
Heating Gas	83.0	67.6		26.5	15.3	1.7
Heating Elec	0.0	0.0		2.4	2.4	2.0
DHW Gas	11.8	11.8		11.8	11.8	2.1
DHW Elec	0.0	0.0		0.0	0.0	0.2
Cooling	5.9	3.3		4.5	4.8	13.0
Lights	39.8	31.0		31.0	20.6	12.4
Plug	26.5	26.5		26.5	22.4	22.4
Fans	13.4	14.8		7.5	7.2	5.8
Pumps	16.0	13.2		13.1	12.0	5.0
Heat Rejection	3.2	2.9		3.3	3.2	0.0

COMMERCIAL RETAIL

Retail	TGS v2 T1 (SB 10 2017)	TGS v2 T2	TGS v3 T1	TGS v3 T2	TGS v3 T3	TGS v3 T4
WWR (%)	20	20		20	20	20
Wall R-Value	20	20		20	20	30
Roof R-Value	20	20		30	30	40
Win U-Value	0.4	0.4		0.3	0.2	0.14
Infil. Savings (%)	Code	Code		25	50	75
Lighting Savings (%)	25	25		25	35	50
Plug Savings (%)	0	0		0	0	0
Fans	Standard	Standard		Standard	Standard	Standard
Heat Recovery (%)	30	55		70	90	90
Vent. Effectiveness	0.8	0.8		0.8	1	1
HVAC	Unitary Gas	Unitary Gas		DOAS FC	DOAS FC	DOAS FC
Plant	-	-		C Boiler/ Cent	ASHP, gas top up	ASHP, elec. top up
DHW Savings	0	0		0	0	0
EUI (kWh/m <sup>2</sup> )	189.9	168.4		113.1	73.4	61.8
TEDI (kWh/m <sup>2</sup> )	75.5	59.7		39.2	20.2	10.7
GHG (kg/m <sup>2</sup> )	24.0	20.0		11.1	3.8	3.1
Targets						
EUI (kWh/m <sup>2</sup> )	<b>190</b>	<b>170</b>	<b>170</b>	<b>120</b>	<b>90</b>	<b>70</b>
TEDI (kWh/m <sup>2</sup> )	<b>75</b>	<b>60</b>	<b>60</b>	<b>40</b>	<b>25</b>	<b>15</b>
GHG (kg/m <sup>2</sup> )	<b>24</b>	<b>20</b>	<b>20</b>	<b>10</b>	<b>5</b>	<b>3</b>
Energy Savings over SB-10	-	<b>11%</b>	<b>11%</b>	<b>37%</b>	<b>53%</b>	<b>63%</b>
Winter	19.0	19.5		17.5	18.6	15.4
Summer	28.0	27.8		21.5	24.7	21.2
Total Gas	109.4	87.2		41.0	0.6	0.0
Total Electricity	80.5	81.2		72.1	72.8	61.8
Heating Gas	106.2	83.9		37.8	0.0	0.0
Heating Elec	2.8	2.8		2.8	7.2	5.7
DHW Gas	3.3	3.3		3.2	0.6	0.0
DHW Elec	0.0	0.0		0.0	0.7	0.0
Cooling	5.7	6.5		4.2	7.8	7.4
Lights	39.6	39.6		39.6	34.3	26.4
Plug	9.8	9.8		9.8	9.8	9.8
Fans	22.5	22.5		12.4	10.4	10.1
Pumps	0.0	0.0		2.4	2.6	2.4
Heat Rejection	0.0	0.0		0.8	0.0	0.0

# APPENDIX D – COSTING ANALYSIS RESULTS

## HIGH-RISE MURB - CAPITAL COST PREMIUMS

	Costing							Total Cost of Construct. (all costs)	Overall % Change in Construct. Costs	Mech Cost per ft2	Lighting + Electrical Upgrades per ft2	Overall Costs per ft2
	Envelope Costing Notes	Wall \$/ft2 Cost	Window \$/ft2 Cost	Roof \$/ft2 Cost	Envelope Cost	Mech/Elec Cost	Upgrade Premium					
TGS v2 T1 (SB-10 2017)	Assumes combination of Window Wall and Precast Concrete	\$70	\$60	\$60	\$6.22M	\$6.71M	\$0.00M	\$64.34M	0.0%	\$25.25	\$2.25	\$263.82
TGS v2 T2	Detailed Calculations were done to show Effective R9-10 can be achieved for multiple wall types, balconies 25% of perimeter length and need not be thermally broken to get R9-10 for all wall types, but costing includes thermally broken balconies	\$83	\$60	\$60	\$7.08M	\$6.83M	\$983k	\$65.33M	1.5%	\$25.74	\$2.25	\$267.85
TGS v3 T1		\$83	\$60	\$60	\$7.08M	\$6.83M	\$983k	\$65.33M	1.5%	\$25.74	\$2.25	\$267.85
TGS v3 T2		\$83	\$74	\$60	\$7.58M	\$7.58M	\$2.23M	\$66.57M	3.5%	\$26.74	\$4.32	\$272.97
TGS v3 T3	Envelope costs remain same because fewer balconies offset costs for increased insulation requirements and better glazing	\$83	\$79	\$60	\$7.75M	\$9.01M	\$3.84M	\$68.18M	6.0%	\$32.64	\$4.32	\$279.55
TGSv3 T4	Increase in costs over T3 are due to better walls, which are primarily offset by removing balconies and window premium due to high performance triple glazing.	\$85	\$84	\$60	\$8.01M	\$7.01M	\$2.29M	\$66.64M	3.6%	\$23.93	\$4.82	\$273.23

LOW-RISE MURB - CAPITAL COST PREMIUMS

	Costing							Total Cost of Construct. (all costs)	Overall % Change in Construct. Costs	Mech Cost per ft2	Lighting + Electrical Upgrades per ft2	Overall Costs per ft2
	Envelope Costing Notes	Wall \$/ft2 Cost	Window \$/ft2 Cost	Roof \$/ft2 Cost	Envelope Cost	Mech/Elec Cost	Upgrade Premium					
TGS v2 T1 (SB-10 2017)	Assumes Wood frame construction, Vinyl Double Glazed Windows	\$35	\$42	\$46	\$1.34M	\$1.57M	\$0.00M	\$13.87M	0.0%	\$25.25	\$2.25	\$243.68
TGS v2 T2	Assumes Wood frame construction, Vinyl Double Glazed Windows	\$35	\$42	\$46	\$1.34M	\$1.63M	\$60k	\$13.93M	0.4%	\$26.31	\$2.25	\$244.74
TGS v3 T1	Assumes Wood frame construction, Vinyl Double Glazed Windows	\$35	\$42	\$46	\$1.34M	\$1.64M	\$71k	\$13.94M	0.5%	\$26.50	\$2.25	\$244.93
TGS v3 T2	Assumes Wood frame construction, Vinyl Double Glazed Windows	\$35	\$55	\$48	\$1.42M	\$1.77M	\$287k	\$14.16M	2.1%	\$26.70	\$4.32	\$248.73
TGS v3 T3	Envelope costs remain same because Assumes Wood frame construction, Vinyl Double Glazed Windows	\$39	\$55	\$50	\$1.51M	\$2.10M	\$713k	\$14.58M	5.1%	\$32.64	\$4.32	\$256.21
TGSv3 T4	Assumes Wood frame construction, Fibreglass Triple Glazed Windows	\$39	\$72	\$50	\$1.60M	\$1.61M	\$685k	\$14.55M	4.9%	\$23.93	\$4.32	\$255.71

COMMERCIAL OFFICE - CAPITAL COST PREMIUMS

	Costing											
	Envelope Costing Notes	Wall \$/ft2 Cost	Window \$/ft2 Cost	Roof \$/ft2 Cost	Envelope Cost	Mechanical & Electrical Cost	Upgrade Premium	Total Cost of Construct. (all costs)	Overall % Change in Construct Costs	Mech Cost per ft2	Lighting + Electrical Upgrades per ft2	Overall Costs per ft2
TGS v2 T1 (SB-10 2017)	Standard Curtain Wall	\$88	\$88	\$60	\$6.98M	\$4.49M	\$0.00M	\$57.82M	0.0%	\$22.93	\$0.00	\$295.00
TGS v2 T2	Standard Curtain Wall, spray foam inside of spandrels	\$90	\$90	\$60	\$7.10M	\$5.34M	\$969k	\$58.79M	1.7%	\$22.93	\$4.32	\$299.94
TGS v3 T1	Standard Curtain Wall, spray foam inside of spandrels	\$90	\$90	\$60	\$7.10M	\$5.70M	\$1.33M	\$59.15M	2.3%	\$24.77	\$4.32	\$301.79
TGS v3 T2	High Performance Curtain Wall, spray foam, triple glazing	\$98	\$98	\$60	\$7.59M	\$5.70M	\$1.82M	\$59.64M	3.1%	\$24.77	\$4.32	\$304.29
TGS v3 T3	High Performance Curtain Wall, spray foam, triple glazing	\$98	\$98	\$60	\$7.59M	\$5.64M	\$1.75M	\$59.57M	3.0%	\$23.93	\$4.82	\$303.95
TGSv3 T4	Precast concrete, better triple glazed windows	\$83	\$84	\$62	\$6.67M	\$5.64M	\$1.28M	\$59.10M	2.2%	\$23.93	\$4.82	\$301.51

COMMERCIAL RETAIL - CAPITAL COST PREMIUMS

	Costing							Total Cost of Construct. (all costs)	Overall % Change in Construct. Costs	Mech Cost per ft2	Lighting + Electrical Upgrades per ft2	Overall Costs per ft2
	Envelope Costing Notes	Wall \$/ft2 Cost	Window \$/ft2 Cost	Roof \$/ft2 Cost	Envelope Cost	Mechanical & Electrical Cost	Upgrade Premium					
TGS v2 T1 (SB-10 2017)	Better precast, double glazing	\$83	\$60	\$60	\$4.17M	\$788k	\$0.00M	\$8.96M	<b>0.0%</b>	\$13.71	\$2.55	\$184.91
TGS v2 T2	Better precast, triple glazing	\$83	\$74	\$60	\$4.22M	\$803k	\$63k	\$9.02M	<b>0.7%</b>	\$14.03	\$2.55	\$186.21
TGS v3 T1	Better precast, triple glazing	\$83	\$74	\$60	\$4.22M	\$803k	\$63k	\$9.02M	<b>0.7%</b>	\$14.03	\$2.55	\$186.21
TGS v3 T2	Better precast, triple glazing	\$83	\$74	\$60	\$4.22M	\$1.32M	\$584k	\$9.54M	<b>6.5%</b>	\$24.77	\$2.55	\$196.95
TGS v3 T3	Better precast, triple glazing	\$83	\$79	\$62	\$4.32M	\$1.37M	\$732k	\$9.69M	<b>8.2%</b>	\$23.93	\$4.32	\$200.01
TGSv3 T4	Better precast, passive house windows	\$85	\$84	\$64	\$4.45M	\$1.37M	\$1.51M	\$10.48M	<b>16.9%</b>	\$23.93	\$4.32	\$216.16

## SUMMARY OF LIFECYCLE COST ANALYSIS RESULTS

Four tables below detail the results of the lifecycle cost analysis for each archetype. Note the following about each of the tables:

- Total Construction Costs do not include the DC Refund, which would decrease these amounts by the value included toward the right side of each table.
- Construction Premiums do not account for the DC Refund.
- Undiscounted Annual Energy Costs are based on 2018 rates.<sup>1</sup> These increase over time with increasing energy prices.
- The Social Cost of Carbon (SCC) is based on Environment and Climate Change Canada's Central rates. The 95th percentile SCC is approximately 3.25x higher. Using the higher SCC would increase the lifecycle cost savings for each Tier.
- Positive values for Lifecycle Cost Savings indicate a net savings versus the baseline, SB-10 2017. Negative values indicate a net loss

### HIGH-RISE MURB

	Construction Costs				Undiscounted Annual Costs			Lifecycle Cost Analysis Results		
	Envelope	Mechanical & Electrical	Total Construction	Construction Premium	Maintenance	Energy	Social Cost of Carbon	Lifecycle Cost Savings before DC Refund	DC Refund	Lifecycle Cost Savings after DC Refund
<b>SB-10 2017</b> (Baseline)	\$6.22M	\$6.71M	\$64.34M	-	\$108k	\$398k	\$26k	-	-	-
<b>TGS v2 T2</b>	\$7.08M	\$6.83M	\$65.33M	1.5%	\$108k	\$362k	\$23k	\$30k	\$510k	\$541k
<b>TGS v3 T1</b>	\$7.08M	\$6.83M	\$65.33M	1.5%	\$108k	\$362k	\$23k	\$30k	-	\$30k
<b>TGS v3 T2</b>	\$7.58M	\$7.58M	\$66.57M	3.5%	\$109k	\$328k	\$17k	-\$229k	\$510k	\$281k
<b>TGS v3 T3</b>	\$7.75M	\$9.01M	\$68.18M	6.0%	\$158k	\$340k	\$9k	-\$2.90M	\$510k	-\$2.39M
<b>TGS v3 T4</b>	\$8.01M	\$7.01M	\$66.64M	3.6%	\$158k	\$342k	\$4k	-\$1.38M	\$510k	-\$873k

<sup>1</sup> <http://www.ec.gc.ca/cc/default.asp?lang=En&n=BE705779-1#SCC-Sec8>



LOW-RISE MURB

	Construction Costs				Undiscounted Annual Costs			Lifecycle Cost Analysis Results		
	Envelope	Mechanical & Electrical	Total Construction	Construction Premium	Maintenance	Energy	Social Cost of Carbon	Lifecycle Cost Savings before DC Refund	DC Refund	Lifecycle Cost Savings after DC Refund
<b>SB-10 2017</b> (Baseline)	\$1.34M	\$1.57M	\$13.87M	-	\$24k	\$89k	\$7k	-	-	-
<b>TGS v2 T2</b>	\$1.34M	\$1.63M	\$13.93M	0.4%	\$24k	\$87k	\$5k	\$27k	\$137k	\$164k
<b>TGS v3 T1</b>	\$1.34M	\$1.64M	\$13.94M	0.5%	\$25k	\$87k	\$5k	-\$1k	-	-\$1k
<b>TGS v3 T2</b>	\$1.42M	\$1.77M	\$14.16M	2.1%	\$26k	\$80k	\$3k	-\$25k	\$137k	\$112k
<b>TGS v3 T3</b>	\$1.51M	\$2.10M	\$14.58M	5.1%	\$37k	\$68k	\$2k	-\$282k	\$137k	-\$144k
<b>TGS v3 T4</b>	\$1.60M	\$1.61M	\$14.55M	4.9%	\$37k	\$72k	\$793	-\$348k	\$137k	-\$210k

COMMERCIAL OFFICE

	Construction Costs				Undiscounted Annual Costs			Lifecycle Cost Analysis Results		
	Envelope	Mechanical & Electrical	Total Construction	Construction Premium	Maintenance	Energy	Social Cost of Carbon	Lifecycle Cost Savings before DC Refund	DC Refund	Lifecycle Cost Savings after DC Refund
<b>SB-10 2017</b> (Baseline)	\$6.98M	\$4.49M	\$57.82M	-	\$84k	\$437k	\$19k	-	-	-
<b>TGS v2 T2</b>	\$7.10M	\$5.34M	\$58.79M	1.7%	\$84k	\$380k	\$16k	\$627k	\$60k	\$687k
<b>TGS v3 T1</b>	\$7.10M	\$5.70M	\$59.15M	2.3%	\$92k	\$380k	\$16k	\$121k	-	\$121k
<b>TGS v3 T2</b>	\$7.59M	\$5.70M	\$59.64M	3.1%	\$92k	\$346k	\$9k	\$643k	\$60k	\$702k
<b>TGS v3 T3</b>	\$7.59M	\$5.64M	\$59.57M	3.0%	\$132k	\$282k	\$7k	\$1.80M	\$60k	\$1.86M
<b>TGS v3 T4</b>	\$6.67M	\$5.64M	\$59.10M	2.2%	\$132k	\$226k	\$3k	\$3.87M	\$60k	\$3.93M

COMMERCIAL RETAIL

	Construction Costs				Undiscounted Annual Costs			Lifecycle Cost Analysis Results		
	Envelope	Mechanical & Electrical	Total Construction	Construction Premium	Maintenance	Energy	Social Cost of Carbon	Lifecycle Cost Savings before DC Refund	DC Refund	Lifecycle Cost Savings after DC Refund
<b>SB-10 2017</b> (Baseline)	\$4.17M	\$788k	\$8.96M	-	\$9k	\$88k	\$5k	-	-	-
<b>TGS v2 T2</b>	\$4.22M	\$803k	\$9.02M	0.7%	\$20k	\$85k	\$4k	-\$191k	\$147k	-\$40k
<b>TGS v3 T1</b>	\$4.22M	\$803k	\$9.02M	0.7%	\$20k	\$85k	\$4k	-\$191k	-	-\$187k
<b>TGS v3 T2</b>	\$4.22M	\$1.32M	\$9.54M	6.5%	\$23k	\$71k	\$2k	-\$345k	\$147k	-\$188k
<b>TGS v3 T3</b>	\$4.32M	\$1.37M	\$9.69M	8.2%	\$33k	\$66k	\$761	-\$524k	\$147k	-\$361k
<b>TGS v3 T4</b>	\$4.45M	\$1.37M	\$10.48M	16.9%	\$33k	\$56k	\$627	-\$1.01M	\$147k	-\$864k

# APPENDIX E – SUMMARY OF PRESCRIPTIVE REQUIREMENTS & CHECKLIST

DEVELOPMENT FEATURE	TIER 1	TIER 2	SPECIFICATIONS, DEFINITIONS, RESOURCES
RENEWABLE & DISTRICT ENERGY	<ul style="list-style-type: none"> <li>✓ <i>Solar Readiness.</i> Ensure that buildings are designed to accommodate connection to solar technologies.</li> <li>✓ <i>District Energy Readiness.</i> Ensure that buildings are designed to enable connection to a district energy system where one exists or is slated for development.</li> </ul>	<ul style="list-style-type: none"> <li>✓ <i>District Energy Connection.</i> Design buildings to connect to a district energy system, where one exists or is slated for development.</li> <li>✓ <i>On-Site Renewable Energy (Optional).</i> Design on-site renewable energy systems to supply at least 5% of the building's total energy load from one or a combination of acceptable renewable energy sources.</li> </ul> <p>OR</p> <ul style="list-style-type: none"> <li>✓ <i>On-Site Renewable Energy (Optional).</i> Design on-site renewable energy systems to supply at least 20% of the building's total energy load from geoechange.</li> </ul>	<p>For solar ready requirements, see NREL's <a href="#">Solar Ready Building Planning Guide</a>.</p> <p>For DES connection requirements, see the City of Toronto's <a href="#">Design Guideline for District Energy-Ready Buildings</a>.</p> <p>Acceptable renewable energy sources may include:</p> <ul style="list-style-type: none"> <li>• <i>Photovoltaic panels:</i> composite panels that convert solar energy into electricity, to be used within the building or exported to the grid</li> <li>• <i>Solar thermal systems:</i> solar thermal collectors that convert solar energy into heating air or water for use within the building</li> <li>• <i>Wind systems:</i> building- or site-integrated wind turbines that convert wind energy to electricity</li> <li>• <i>Biogas systems:</i> fuel cells that use biogas to convert hydrogen and oxygen into electricity</li> <li>• <i>Geoechange systems:</i> the use of ground source heat pumps that harness heat from the ground surrounding a building.</li> </ul> <p>Savings must be demonstrated by third-party non-commercial energy modelling tools such as RETScreen and whole-building modelling software utilized for [GHG1.1]</p>
SUBMETERING	<ul style="list-style-type: none"> <li>✓ <i>Meters.</i> Design buildings to include thermal submeters at a floor-by-floor scale for commercial buildings, and for defined use (e.g. parking, amenity areas, and common areas) for residential units.</li> </ul>	<ul style="list-style-type: none"> <li>✓ <i>Meters.</i> Design buildings to include energy meters for each heating/cooling appliance in all residential units.</li> </ul> <p>OR</p> <p>Design buildings to include energy meters for each individual tenant in multi-tenant commercial/retail buildings.</p>	<p>All thermal energy meters must be "true" energy meters capable of measuring flow rates as well as supply and return temperatures and computing energy consumption. Meters shall conform to CSA (Canadian Standards Association) Standard C 900 Heat Meter Standard or to CEN (European Committee for Standardization) Standard EN 1434.</p> <p>Energy and water metering will be required by the new provincial energy benchmarking legislation. For more information, visit the City of Toronto's <a href="#">website</a> for updates.</p> <p>IPMVP (International Performance Measurement and Verification Protocol) provides a framework to determine energy and water savings resulting from the implementation of an energy efficiency program and the standards for creating a Measurement &amp; Verification Plan, including requirements for designing a sub-metering system. For strategies to implement, see the International Performance Measurement and Verification Protocol Volume I.</p>
AIR TIGHTNESS TESTING	<ul style="list-style-type: none"> <li>✓ N/A</li> </ul>	<ul style="list-style-type: none"> <li>✓ Conduct a whole-building Air Tightness Test to improve the quality and airtightness of the building envelope.</li> </ul>	<p>The practice of testing a building's air-tightness is a way to measure the rate of air leakage from a building envelope. The process is conducted by sealing up all building openings (e.g. operable windows) and pressurizing a building to determine its resistance to air leakage through the envelope.</p> <p>Refer to the US Army Corps of Engineers' <a href="#">Air Leakage Test Protocol for Building Envelopes</a> as a guideline for whole building air tightness testing.</p>

BUILDING COMMISSIONING	<ul style="list-style-type: none"> <li>✓ Commission the project using fundamental commissioning practices.</li> </ul>	<ul style="list-style-type: none"> <li>✓ Commission the project using best commissioning practices.</li> </ul>	<p>Commissioning of a building is a systematic process that documents and verifies that all the facility's energy related systems perform interactively in accordance with the design documentation and intent, and according to the owner's operational requirements from the design phase through to at least one-year post construction. For more information on the process of building commissioning, see <a href="#">The Building Commissioning Guide</a>.</p> <p>Refer to LEED v4 NC <a href="#">Fundamental Commissioning and Verification</a> and <a href="#">EA Credit 1 for Enhanced Commissioning</a> for procedural guidelines.</p> <p>Building commissioning should be performed according to ASHRAE Guideline 0-2005 and Guideline 1.1-2007.</p>
ENERGY BENCHMARKING	<ul style="list-style-type: none"> <li>✓ Register the building on ENERGYSTAR® Portfolio Manager and name the City of Toronto as a Reviewer.</li> </ul>	<ul style="list-style-type: none"> <li>✓ Report and benchmark the building's annual energy consumption.</li> </ul>	<p>Building energy benchmarking is a process through which building owners and/or managers are required to track and report their building's energy performance.</p> <p>Go to the ENERGY STAR® <a href="#">Portfolio Manager website</a> for information on how to benchmark your building.</p> <p>Visit the City of Toronto website for more information on Ontario's <a href="#">energy benchmarking program</a>.</p>
RESILIENCE	<ul style="list-style-type: none"> <li>✓ N/A</li> </ul>	<ul style="list-style-type: none"> <li>✓ Complete Resilience Checklist.</li> <li>✓ <i>Refuge Area (Optional)</i>. Provide a refuge area with cooling available (MURB only).</li> <li>✓ <i>Back-Up Generation (Optional)</i>. Provide 72 hours of back-up generation.</li> </ul>	<p>Refuge areas should be a minimum of 93m<sup>2</sup> (1000 square feet), and/or 0.5m<sup>2</sup>/occupant.</p>

# APPENDIX F – RESILIENCE CHECKLIST

## CLIMATE CHANGE RESILIENCE CHECKLIST FOR NEW DEVELOPMENT

### WHY DO WE NEED A RESILIENCE CHECKLIST?

In 2014, the City of Toronto adopted the Resilient City – Preparing for a Changing Climate report, which outlines a series of actions and strategies to improve the city's resilience and reduce its contributions to climate change. Improving the ability of the city's buildings to withstand the impacts of climate change is an important step in this work and key to protecting the health and well-being of the city's residents and businesses. The aim of this checklist is to help improve the resilience to climate change of Toronto buildings. It has been specifically designed to ensure that new buildings constructed in the City of Toronto are resilient to the impacts of a changing climate and extreme weather events.

### WHAT CAN WE EXPECT FROM A FUTURE CLIMATE?

The need for a climate change resilience checklist is based on the expected changes in weather patterns and extreme weather events projected by climate change scenarios. The City of Toronto's Future Weather and Climate Driver Study (2011) provides a series of climate projections for the city for the years 2040 to 2049.<sup>x</sup> These projections give us a greater understanding of the changes to Toronto's climate that we can anticipate in the future, and that should therefore be considered in building design (see Table 1). Some of the key predictions presented in the report are summarized below:

An increase in average annual temperatures

- Average annual temperatures will increase by 4.4°C
- The projected average winter temperature will increase by 5.7°C
- The projected average summer temperature will increase by 3.8°C
- Extreme daily minimum temperatures will increase by 13°C
- The number of days above 20°C will increase from 133 days to 160 days
- The number of days above 0°C will increase by 16%
- The number of "heat waves" (i.e. events with more than three consecutive days of temperatures greater than 32°C) is expected to increase from an average of 0.57 occurrences per year to five occurrences per year
- An increase in the number of days requiring air conditioning from 10 to 180
- A decrease in the number days requiring extra heating from 440 to 60

Changes to precipitation and wind speed

- Slightly more precipitation (snow plus rainfall) is expected overall, with the highest increases expected for the months of July (+80%) and August (+50%)
- Less snow and more rain in the winter is expected, with 26 fewer snow days expected per year
- A smaller number of storm events is expected, but the amount of precipitation in these events will increase
- Extreme daily rainfall will increase threefold in the month of June
- Overall wind speeds will remain the same, while maximum wind speeds will decrease

Table 1: Projected Future Weather Changes for 2040-2049 (replicated directly from Toronto's Future Weather and Climate Driver Study, Volume 1, 2011)

Weather Type	Parameter	2000-2009	2040-2049
Extreme precipitation	Maximum in one day (in mm)	66	166
	Number of days with more than 25 mm	19	9
	Mean annual daily maximum in mm	48	86
	100 year return period maximum daily (in mm)	81	204
	10 year return period maximum daily (in mm)	62	135
	10 year maximum return hourly (in mm)	20	39
Extreme rain	Maximum in one day (in mm)	66	166
	Number of days with more 25mm	16	9
Extreme snowfall	Maximum in one day (in cm)	24	18
	Number of days with more than 5cm	16	3
Extreme heat	Maximum daily (in °C)	33	44
	Number of days with more than 30°C	20	66
Extreme cold	Minimum daily (in °C)	-17	-11
	Number of days with less than -10°C	24.6	0.3
	Number of days with minimum less than 0°C	128	70
Wind chill	Extreme daily	-24	-17
	Number of days with less than -20°C	12	0
Degree days	Number of degree days greater than 24°C (air conditioning required)	10	180
	Number of degree days less than 0°C	3452	4857
	Number of degree days less than 0°C (extra heating required)	440	66
Extreme wind	Maximum hourly speed in km/hour	92	48
	Maximum gust speed in km/hour	130	75
	Number of days with wind speed greater than 52 km/hour	0.9	0.0
	Number of days with wind speed greater than 63 km/hour	0.3	0.0
Humidex	Maximum (in °C)	48	57
	Number of days greater than 40 °C	9	39
Storms	Average number of storms per year	30	23
	Average number of summer storms in one year	17	17
	Average number of winter storms in one year	14	6
	Average SRH (vortices potential) in one year	1281	691
	Average CAPE (convective energy potential) in one year	3841	4097
	Average EHI (combination of SRH and CAPE) in one year	3.6	4.3

## WHAT RESPONSES WILL HELP IMPROVE BUILDING RESILIENCE?

The overall impact of these changes in climate on the building sector will be primarily experienced in Toronto as a higher risk of flooding events, extreme heat events, and power outages.

To reduce the impact of these expected changes in climate on Toronto's building sector, new buildings must be constructed in such a way as to mitigate flood events, improve thermal resilience, and extend the duration of back-up power generation. The achievement of these measures can already be facilitated by achieving compliance with the Toronto Green Standard (TGS), the City of Toronto's performance standard for sustainable buildings. However, this checklist provides additional assurance that new construction will safeguard the wellbeing of Toronto residents and improve the reliability of its infrastructure.

**FLOODING EVENTS** An increase in the overall volume of precipitation and the volume of precipitation during individual storm events creates a higher risk of flooding events in certain areas of Toronto. The Toronto and Region Conservation Authority (TRCA) has instituted several measures and resources for the regulation of flooding in Toronto, including flood plain mapping resources that help identify flood-prone areas of the city.<sup>xxi</sup>

The TGS's section on Stormwater Retention also outlines several measures to reduce new buildings' impact on overland runoff. These include:

- **Stormwater balance (Tier 1):** Retain stormwater on-site to same level of annual volume of overland runoff allowable under pre-development conditions.
- **Stormwater retention and reuse (Tier 2):** Retain at least the first 5mm from each rainfall through rainwater reuse, on-site infiltration and evapotranspiration.
- **Enhanced stormwater retention and reuse (Tier 2):** Retain 10 mm of each 24 hour rainfall event, or 70% of total average annual rainfall depth, for rainwater reuse, on-site infiltration and/or evapotranspiration.

However, while these measures help to ensure new buildings reduce overall stormwater runoff in the city, this checklist includes specific measures intended to reduce the potential impact of flooding events on building systems themselves. These will in turn remove the burden of costly repairs to building systems for building managers, and protect citizens from damage and risk from flooding events.

**EXTREME HEAT EVENTS** The risks associated with the impact of extreme heat events on vulnerable populations have been documented at length by City of Toronto authorities (e.g. Toronto Board of Health). The Board of Health has presented research that indicates a potential doubling of current heat-related illness and death under a warmer climate to 2049.<sup>xxii</sup> Measures to protect at-risk residents (e.g. the elderly, socially isolated, those with pre-existing illness, and young children) and those without access to air conditioning from excessive heat will therefore be important to include into the design and operation of Toronto's buildings.

**PASSIVE SURVIVABILITY** refers to a building's ability to maintain critical life-support functions and conditions for its occupants during extended periods of absence of power, heating fuel, and/or water.

**THERMAL RESILIENCE** is one dimension of passive survivability, and refers to a building's ability to maintain liveable temperatures in the event of a power outage or disruption in fuel supply for prolonged periods of time.

Energy modelling conducted in the development of Version 3 of the TGS has shown a correlation between the achievement of higher levels of building energy performance and improved thermal resilience. Buildings designed with thicker building envelopes, lower glazing ratios, lower incidences of thermal bridging, or other highly efficient building strategies help to maintain liveable indoor temperatures with less energy and for longer periods of time under power outages. Buildings with lower overall energy use intensity (EUI) and superior thermal performance also require less back-up fuel during periods of power outages, lengthening the duration of back-up generation reserves or energy storage. Specific strategies to reduce residents' vulnerability to extreme heat events may take many forms, but can be arranged into a hierarchy of descending priority:<sup>xxiii</sup>

1. Minimize internal heat generation through energy efficient design;
2. Reduce the amount of heat entering a building in summer through orientation, shading, albedo, fenestration, insulation and green roofs and walls;
3. Manage the heat within the building through exposed internal thermal mass and high ceilings;
4. Passive ventilation;
5. Mechanical ventilation; and
6. Active cooling systems (ensuring they are the lowest carbon options).

Other strategies may be more operational, including the provision of support, guidelines and resources for property managers, operators, and residents to cope with extreme heat events. A local example of such a resource is the *Office of Emergency Management's Get Emergency Ready: High-rise Living* guide for high-rise apartment dwellers.<sup>xxiv</sup>

**POWER OUTAGES** Finally, the impact of a warmer climate and more extreme weather events can have an effect on the reliability of our power supply. As temperatures rise, our use of air conditioning also increases, putting stress on the ability of the power grid to deliver electricity. Periods of extreme heat are increasingly leading to brownouts and blackouts, as are events in the fall/winter such as Toronto's December 2013 ice storm. Research from past events of this nature has shown that power restoration can take as long as 3 days for several areas of the city. Ensuring that new buildings are constructed in such a way that their reliance on the power grid is minimized and/or back-up generation supplies last longer will reduce both the likelihood and the impact of possible power outages.

#### HOW DO I SUBMIT MY CHECKLIST?

- TBD by City of Toronto staff
- Details will include when the checklist must be submitted, with what other TGS documentation, and to whom
- To include link to website for more info + contact for assistance



## CHECKLIST REQUIREMENTS

### A. APPLICATION STATUS

- Site Plan Control                       Zoning Bylaw Amendment                       Draft Plan of Subdivision
- Official Plan Amendment

### B. PROJECT INFORMATION

Applicant Name: \_\_\_\_\_

Telephone: \_\_\_\_\_ Email: \_\_\_\_\_

Project Address: \_\_\_\_\_

Registered Owner: \_\_\_\_\_

Architect: \_\_\_\_\_

Engineer: \_\_\_\_\_

### C. BUILDING INFORMATION

Building purpose/intended use: \_\_\_\_\_

Principal construction type (wood frame, masonry, steel frame, concrete): \_\_\_\_\_

First floor use(s): \_\_\_\_\_

Site area (m<sup>2</sup>): \_\_\_\_\_ Gross Floor Area (m<sup>2</sup>): \_\_\_\_\_

Number of units: \_\_\_\_\_ Number of storeys: \_\_\_\_\_

Number of below-grade levels: \_\_\_\_\_ Projected occupancy: \_\_\_\_\_

### D. ENERGY PERFORMANCE

For clarity on modelled energy performance, consult the TGS Energy Modelling Guidelines at [\[link\]](#).

Tier of TGS to be achieved: Tier 1                       Tier 2

Other green building certification to be achieved (if applicable): \_\_\_\_\_

Modelled Energy Use Intensity (kWh/m<sup>2</sup>/yr.): \_\_\_\_\_

Modelled Thermal Energy Demand Intensity (kWh/m<sup>2</sup>/yr.): \_\_\_\_\_

Modelled Peak Energy Demand Intensity (kW/m<sup>2</sup>/yr.): \_\_\_\_\_

Overall R value: \_\_\_\_\_

## E. MODELLING ASSUMPTIONS

For expected changes in climate across the Greater Toronto Area, consult Toronto's [Future Weather and Climate Driver Study](#).

Has any enhanced modelling using future climate data been conducted for the building site?

No                      Yes

If yes, what time period was considered? \_\_\_\_\_

What temperature minimums/maximums were considered in building design?

Temperature Low (°C) \_\_\_\_\_ Temperature High (°C):

\_\_\_\_\_

What variables were assumed for extreme heat events, if any?

Temperature Max (°C): \_\_\_\_\_ Duration of events (days): \_\_\_\_\_

Frequency (events/year): \_\_\_\_\_

What variables were assumed for extreme flooding events, if any?

Daily rainfall max (mm): \_\_\_\_\_ Duration of extreme rainfall events (days): \_\_\_\_\_

Frequency (events/year): \_\_\_\_\_

## F. THERMAL RESILIENCE AND SAFETY

What measures have been taken to reduce the impacts of heat waves?

### ***Building - passive***

- |   |   |  |
|---|---|--|
| <input type="checkbox"/> Higher roof R values                 | <input type="checkbox"/> Operable windows                     | <input type="checkbox"/> External window shading devices |
| <input type="checkbox"/> Higher envelope R values             | <input type="checkbox"/> Window films                         | <input type="checkbox"/> Triple glazed windows           |
| <input type="checkbox"/> Cool/green roof materials            | <input type="checkbox"/> Ceiling fans                         | <input type="checkbox"/> High albedo envelope            |
| <input type="checkbox"/> Tenant emergency preparedness guides | <input type="checkbox"/> Other passive ventilation strategies |  |

### ***Building – active***

- Indoor refuge area with cooling
- Centralized air conditioning

### ***Building – site***

- |   |  |  |
|---|--|--|
| <input type="checkbox"/> High albedo landscaping materials              | <input type="checkbox"/> Soft landscaping                  | <input type="checkbox"/> Shade trees/shrubs        |
| <input type="checkbox"/> External pools (e.g. splash pads)              | <input type="checkbox"/> Reduced hardscapes                | <input type="checkbox"/> Use of solar PV as shades |
| <input type="checkbox"/> Shade structures                               | <input type="checkbox"/> Outdoor shaded space with seating |  |
| <input type="checkbox"/> High albedo hardscapes, including parking lots |  |  |

Has a refuge area with cooling been provided in the building (MURB only)? Yes No

If so, what is the total area? (m2) \_\_\_\_\_

Refuge areas should be a minimum of 93m<sup>2</sup> (1000 square feet), and/or 0.5m<sup>2</sup>/occupant.

What services are provided? \_\_\_\_\_  
\_\_\_\_\_

If not, what measures will be taken to provide residents with access to cooling centres? \_\_\_\_\_  
\_\_\_\_\_  
\_\_\_\_\_

### G. BACK-UP GENERATION

Consult the City of Toronto's Minimum Backup Power Guidelines for MURBs<sup>xxv</sup> for additional information on critical services in residential buildings.

What measures have been used to reduce the building's energy demand on the grid?

- On-site solar PV
- CHP system
- District energy ready
- On-site solar thermal
- Ground source heat pump
- Smart grid ready
- On-site storage
- Microgrid connected
- Building-integrated wind turbines
- Other \_\_\_\_\_

What form of back-up power/emergency generator system has been selected? \_\_\_\_\_  
\_\_\_\_\_

Is storage adequate to provide 72 hours of back-up generation (MURB only)?

- Yes
- No

Total storage capacity (kW): \_\_\_\_\_ Total back-up generation fuel (units):  
\_\_\_\_\_

What critical services have been included into back-up power generation calculations?

- Passenger elevator(s)
- Security systems
- Sump pumps
- Unit space heating
- Unit space cooling
- Refuge area heating
- Refuge area cooling
- Refuge area lighting
- Refuge area electricity
- Hot water boilers/pumps
- Domestic water booster pumps
- Other \_\_\_\_\_

What is the peak energy demand of critical systems in event of a power outage?  
\_\_\_\_\_

How many hours will critical services remain operable under a power outage?  
\_\_\_\_\_

## H. FLOOD MITIGATION

List any flood prevention measures used to mitigate the impact of heavy rainfall events and associated risk of flooding within the building:

Electrical and HVAC Systems located above 1st floor

Back-up generator/fuel located above 1st floor

Ground floor electrical circuits located in ceiling

Waste water back flow prevention

Water tight utility conduits

Storm water back flow prevention

Deployable barricades

List the strategies used to accommodate heavy rainfall events under the Stormwater Retention (Water Balance) section of the TGS (as identified in your Storm Water management Report): \_\_\_\_\_

---

---

---

Is the building site located in a flood plain? Yes No

If so, what is the regional storm elevation? \_\_\_\_\_

For more information on regional storm elevations, consult the Toronto Regional Conservation Authority's [Flood Plain Management and Flood Mapping Resources](#).

## I. MANAGER & TENANT PREPAREDNESS

Will building management have access to a vulnerable person's list? Yes No

Will a 72-hour preparedness kit available in the building? Yes No

If so, has building management been made aware of the location of the preparedness kit?

Yes No

What additional resources for emergency preparedness have been made available to building managers, operators, and/or tenants?

---

---

---

# RESOURCES & REFERENCES CITED

- <sup>i</sup>City of Toronto. 2007. Change is in the Air. Climate Change, Clean Air and Sustainable Energy Action Plan: Moving from Framework to Action. Accessed January 10th 2017 from [https://www1.toronto.ca/City%20Of%20Toronto/Environment%20and%20Energy/Programs%20for%20Residents/Files/pdf/C/clean\\_air\\_action\\_plan.pdf](https://www1.toronto.ca/City%20Of%20Toronto/Environment%20and%20Energy/Programs%20for%20Residents/Files/pdf/C/clean_air_action_plan.pdf)
- <sup>ii</sup>City of Toronto. 2009. The Power to Live Green. Toronto's Sustainable Energy Strategy. Accessed January 10th from [https://www1.toronto.ca/city\\_of\\_toronto/environment\\_and\\_energy/key\\_priorities/files/pdf/2009-10\\_report.pdf](https://www1.toronto.ca/city_of_toronto/environment_and_energy/key_priorities/files/pdf/2009-10_report.pdf)
- <sup>iii</sup>Staff Report for Action on TransformTO Progress Report. 2016. Accessed on January 9th 2017 from: <http://www.toronto.ca/zzvv/mmis/2016/pe/bgrd/backgroundfile-98039.pdf>
- <sup>iv</sup>Province of Ontario. Ontario's Five Year Climate Change Action Plan 2016-2020. Accessed January 9th from [http://www.applications.ene.gov.on.ca/ccap/products/CCAP\\_ENGLISH.pdf](http://www.applications.ene.gov.on.ca/ccap/products/CCAP_ENGLISH.pdf)
- <sup>v</sup>GHG Emissions. Accessed January 7th from <http://taf.ca/climate/urban-ghg-emissions/>
- <sup>vi</sup>City of Toronto. 2008. Climate Change Adaptation Strategy. Accessed January 10th 2017 from <http://www.toronto.ca/legdocs/mmis/2008/pe/bgrd/backgroundfile-12950.pdf>
- <sup>vii</sup>SENES Consultants Ltd. 2011. Toronto's Future Weather and Climate Driver Study. Accessed January 10th from [http://www1.toronto.ca/city\\_of\\_toronto/environment\\_and\\_energy/key\\_priorities/files/pdf/tfwcds-full-report.pdf](http://www1.toronto.ca/city_of_toronto/environment_and_energy/key_priorities/files/pdf/tfwcds-full-report.pdf)
- <sup>viii</sup>Integral Group. 2015. Global Best Practices in Energy Efficiency Policy. Prepared for the City of Toronto. Accessed January 10th from <https://www1.toronto.ca/City%20Of%20Toronto/City%20Planning/Developing%20Toronto/Files/pdf/TGS/Global%20Best%20Practices%20in%20Energy%20Efficiency%20Policy%20July%202016%202015.pdf>
- <sup>ix</sup>Better Buildings Partnership. 2013. Energy Analysis of Toronto Green Standard Projects 2011-2012. Accessed May 5 2015 from: [http://www1.toronto.ca/City%20Of%20Toronto/City%20Planning/Developing%20Toronto/Files/pdf/TGS/TGS\\_2014\\_Update\\_HIGHLIGHTS.pdf](http://www1.toronto.ca/City%20Of%20Toronto/City%20Planning/Developing%20Toronto/Files/pdf/TGS/TGS_2014_Update_HIGHLIGHTS.pdf)
- <sup>x</sup>RDH Building Engineering. 2012. Energy Consumption and Conservation in Mid- and High-Rise Residential Buildings in British Columbia. Accessed May 5 2015 from: <http://www.hpo.bc.ca/sites/www.hpo.bc.ca/files/download/Report/MURB-EnergyStudy-Report.pdf>
- <sup>xi</sup>"New York City Local Law 84 Benchmarking Report" September, 2013. Accessed May 5 2015 from: [http://www.nyc.gov/html/planydc/downloads/pdf/publications/l184\\_year\\_two\\_report.pdf](http://www.nyc.gov/html/planydc/downloads/pdf/publications/l184_year_two_report.pdf)
- <sup>xii</sup>Energy Efficiency Office Comments and Standard Conditions Memorandum. 2016. Site Plan Control Application No. 15 215421 STE 28 SA.
- <sup>xiii</sup>City of Toronto. 2016. Design Guideline for District Energy-Ready Buildings. [http://www1.toronto.ca/City%20Of%20Toronto/Environment%20and%20Energy/Programs%20for%20Businesses/BBP/PDFs/District%20Energy%20Ready%20Guideline\\_September%202016.pdf](http://www1.toronto.ca/City%20Of%20Toronto/Environment%20and%20Energy/Programs%20for%20Businesses/BBP/PDFs/District%20Energy%20Ready%20Guideline_September%202016.pdf)
- <sup>xiv</sup>Seattle Energy Code. 2015. <http://www.seattle.gov/DPD/codesrules/codes/energy/overview/>.
- <sup>xv</sup>US Army Corps of Engineers. 2012. Air Leakage Test Protocol for Building Envelopes. [https://www.wbdg.org/pdfs/usace\\_airleakagetestprotocol.pdf](https://www.wbdg.org/pdfs/usace_airleakagetestprotocol.pdf)
- <sup>xvi</sup>Energy Design Resources Design Brief. Chiller Plant Efficiency. Accessed December 13 2016 from: [https://energydesignresources.com/media/1681/edr\\_designbriefs\\_chillerplant.pdf?tracked=true](https://energydesignresources.com/media/1681/edr_designbriefs_chillerplant.pdf?tracked=true)
- <sup>xvii</sup>Integral Group, 2013. CEATI Technical Report. Prepared for CEATI International, September 30 2013.
- <sup>xviii</sup>Canada Green Building Council. 2016. Zero Carbon Buildings Framework for Commercial, Institutional and Multi-Family Buildings in Canada.
- <sup>xix</sup>Innovative approaches for reducing GHG emissions: feebates for appliances and buildings. [http://energy-solution.com/wp-content/uploads/2015/01/Innovative-Approaches-for-Reducing-GHG-Emissions\\_EnergySolutions\\_ACEEE-2010.pdf](http://energy-solution.com/wp-content/uploads/2015/01/Innovative-Approaches-for-Reducing-GHG-Emissions_EnergySolutions_ACEEE-2010.pdf)
- <sup>xx</sup>City of Toronto. 2011. Toronto's Future Weather and Climate Driver Study. Prepared by SENES Consultants Ltd. [http://www1.toronto.ca/city\\_of\\_toronto/environment\\_and\\_energy/key\\_priorities/files/pdf/tfwcds-full-report.pdf](http://www1.toronto.ca/city_of_toronto/environment_and_energy/key_priorities/files/pdf/tfwcds-full-report.pdf)

<sup>xxi</sup>Toronto and Region Conservation Authority. 2016. Flood Plain Management. <https://trca.ca/conservation/flood-risk-management/flood-plain-management/>.

<sup>xxii</sup>City of Toronto. 2015. Reducing Health Risk from Extreme Heat in Apartment Buildings. Staff Report. <http://www1.toronto.ca/City%20Of%20Toronto/Toronto%20Public%20Health/Healthy%20Environment/heat%20alert/Files/pdf/B/BOH%20Rpt%20Heat%20final%20June%202015.pdf>

<sup>xxiii</sup>City of London. 2016. The London Plan, Chapter 5 – London' Response to Climate Change. <https://www.london.gov.uk/what-we-do/planning/london-plan/current-london-plan/london-plan-chapter-five-londons-response/policy-59-overheating-and>

<sup>xxiv</sup>City of Toronto. Get Emergency Ready. High Rise Living. [https://www1.toronto.ca/City%20Of%20Toronto/Office%20of%20Emergency%20Management/Files/pdf/O/OEM\\_HighRiseGuide.pdf](https://www1.toronto.ca/City%20Of%20Toronto/Office%20of%20Emergency%20Management/Files/pdf/O/OEM_HighRiseGuide.pdf)

<sup>xxv</sup>City of Toronto. 2016. Minimum Backup Power Guidelines for MURBs. Voluntary Performance Standards for Existing and New Buildings. [http://www1.toronto.ca/City%20Of%20Toronto/Environment%20and%20Energy/Programs%20for%20Businesses/BBP/PDFs/Minimum%20Backup%20Power%20Guideline\\_October%202016.pdf](http://www1.toronto.ca/City%20Of%20Toronto/Environment%20and%20Energy/Programs%20for%20Businesses/BBP/PDFs/Minimum%20Backup%20Power%20Guideline_October%202016.pdf)